

PRODUCT DATA:

INPUT VOLTAGE	OUTPUT CURRENT	OUTPUT POWER	REMARKS	SIZE (LXWXH)	PROTECTION
12-24V DC	5 X 8A	5 X (96-192)W	CONSTANT VOLTAGE	6.46" X 2.87" X 1.50"	SHORT CIRCUIT

FEATURES:

- RDM function can realize intercommunication between DMX master and decoder.
- Easy to set and show DMX address on built-in digital display.
- Multiple kinds of DMX in/out ports: RJ 45, XLR , normal screws.
- Total 5 PWM output channels. DMX channel quantity from 1CH~5CH settable
- PWM output resolution ratio 8bit , 16bit settable.
- Output PWM frequency from 500HZ ~ 30K HZ settable.
- Output dimming curve gamma value from 0.1 ~ 9.9 settable.
- Decoding mode settable.
- Galvanic isolation

FUNCTION INTRODUCTION:

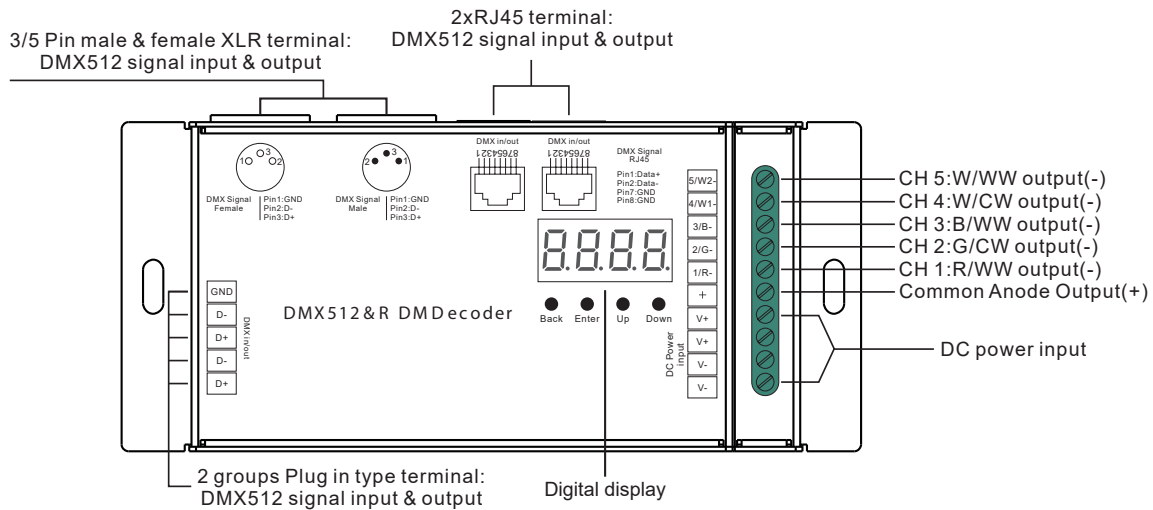

SAFETY INFORMATION

WARNING: These products may represent a potential shock or fire hazard if improperly installed or attached in any way. Products should be installed in accordance with these instructions, local electrical codes and the National Electric Code (NEC).

- DO NOT install with power applied to device.
- DO NOT operate the dial switches for device mode selection with power applied to device.
- DO NOT expose the device to moisture.

Button introduction







Operation

Up, Down button is for menu selection. After power on the decoder, if keep on clicking Up button, you will find below menu on display:

DMX signal indicator ●: When DMX signal input is detected, the indicator on the display following after  turns on red .XXX



● ● ● ●
 Back Enter Up Down

-  Means DMX address. factory defaults setting is 001.
-  Means DMX channels quantity. factory defaults setting is Ch05
-  Means Bit (8bit or 16bit). factory defaults setting is 16bit
-  Means output PWM frequency. factory defaults setting is 1K HZ
-  Means output dimming curve gamma value, factory defaults setting is ga 1.5
-  Means Decoding mode, factory defaults setting is dp1.1

Wiring Diagram

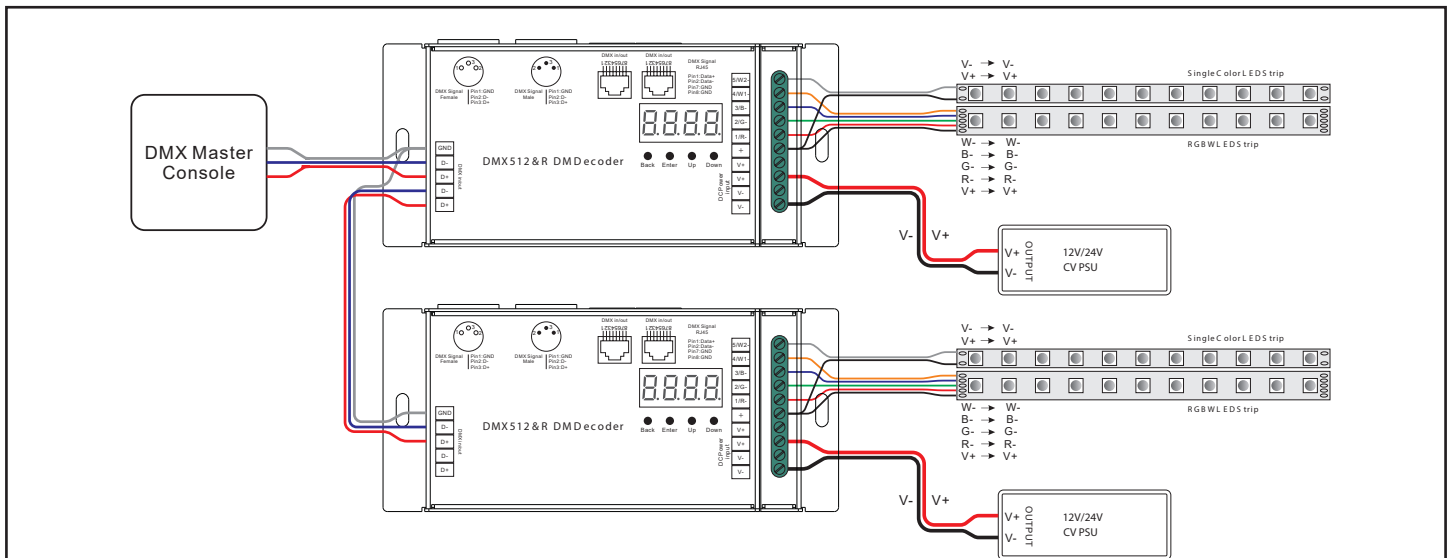

1. DMX address setting:

Select menu  press button "Enter" until, display flashes, then press or hold button "Up" / "Down" to set DMX address, then press button "Back" to confirm.

2. DMX channel quantity setting:

Select menu,  press button "Enter", display flashes, then click button "Up" / "Down" to set DMX channel quantity, then press button "Back" to confirm.

For example the DMX address is already set 001.

CH01=1 DMX address for all the output channels, which are all address 001.

CH02=2 DMX addresses, output 1&3 is address 001, output 2,4&5 is address 002.

CH03=3 DMX addresses, output 1, 2 is address 001,002, output 3,4&5 is address 003.

CH04=4 DMX addresses, output 1,2,3 is address 001,002,003, output 4&5 is address 004.

3. PWM output resolution Bit setting:

Select menu  press button "Enter", display flashes, then press button "Up" / "Down" to choose 08 or 16 bit, then press button "Back" to confirm.

4. output PWM frequency setting:

Select menu **88XX**, press button "Enter", display flashes, then press button "Up" / "Down" to choose 00~30, then press button "Back" to confirm. 00=500HZ, 01=1kHz, 02=2kHz.....30=30kHz.

5. output dimming curve gamma value setting:

Select menu **88XX**, press button "Enter", display flashes, then click or hold button "Up" / "Down" to choose 0.1~9.9, then press button "Back" to confirm.

6. output dimming curve gamma value setting:

Select menu **88XX**, press button "Enter", display flashes, then press or hold button "Up" / "Down" to choose the decoding mode, then press button "Back" to confirm. "dPxx" means the DMX address quantity used for control of corresponding PWM output channel quantity. 1st "x" is DMX address quantity, 2nd "x" is PWM channel quantity.

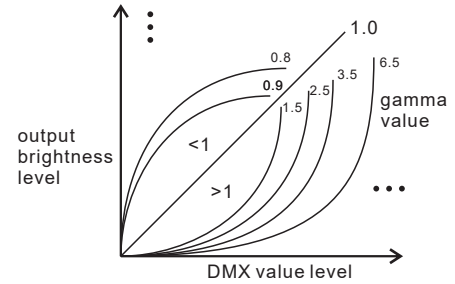

Micro dimming: the micro dimming effect can only be visible when the dimming curve gamma value is set lower than 1.4, and the lower the value is, the more visible the micro dimming effect will be.

DMX address is 001, CH01

DMX Console Slider number	dp1.1	dp2.1
DMX channel		
1	for all output dimming	for all output dimming
2	No use	for all output micro dimming

DMX address is 001, CH02

DMX Console Slider number	dp1.1	dp2.1	dp3.2
DMX channel			
1	for output 1&3 dimming	for output 1&3 dimming	for output 1&3 dimming
2	for output 2,4 &5 dimming	for output 1&3 micro dimming	for output 2,4 &5 dimming
3		for output 2,4 &5 dimming	for all output dimming
4		for output 2,4&5 micro dimming	

DMX address is 001, CH03

DMX Console Slider number	dp1.1	dp2.1	dp4.3	dp5.3
DMX channel				
1	for output 1 dimming	for output 1 dimming	for output 1 dimming	for output 1 dimming
2	for output 2 dimming	for output 1 micro dimming	for output 2 dimming	for output 2 dimming
3	for output 3,4 &5 dimming	for output 2 dimming	for output 3,4&5 dimming	for output 3,4&5 dimming
4		for output 2 micro dimming	for all output master dimming	for all output master dimming
5		for output 3,4 &5 dimming		strobe effects
6		for output 3,4&5 micro dimming		

DMX address is 001, CH04

DMX Console Slider number / DMX channel	dp1.1	dp2.1	dp5.4	dp6.4
1	for output 1 dimming	for output 1 dimming	for output 1 dimming	for output 1 dimming
2	for output 2 dimming	for output 1 micro dimming	for output 2 dimming	for output 2 dimming
3	for output 3 dimming	for output 2 dimming	for output 3 dimming	for output 3 dimming
4	for output 4&5 dimming	for output 2 micro dimming	for output 4&5 dimming	for output 4&5 dimming
5		for output 3 dimming	for all output master dimming	for all output master dimming
6		for output 3 micro dimming		strobe effects
7		for output 4 &5 dimming		
8		for output 4&5 micro dimming		

DMX address is 001, CH05

DMX Console Slider number / DMX channel	dp1.1	dp2.1	dp6.5	dp7.5
1	for output 1 dimming	for output 1 dimming	for output 1 dimming	for output 1 dimming
2	for output 2 dimming	for output 1 micro dimming	for output 2 dimming	for output 2 dimming
3	for output 3 dimming	for output 2 dimming	for output 3 dimming	for output 3 dimming
4	for output 4 dimming	for output 2 micro dimming	for output 4 dimming	for output 4 dimming
5	for output 5 dimming	for output 3 dimming	for output 5 dimming	for output 5 dimming
6		for output 3 micro dimming	for all output master dimming	for all output master dimming
7		for output 4 dimming		strobe effects
8		for output 4 micro dimming		
9		for output 5 dimming		
10		for output 5 micro dimming		

Short circuit protection

If short circuit of the connected load is detected, the display will flash to alarm and the load will be forced to open circuit status. Once the fault is removed, the decoder will recover after re-powered on.

The data definitions for strobe channel are as follows:

- {0, 7},//undefined
- {8, 65},//slow strobe-->fast strobe
- {66, 71},//undefined
- {72, 127},//slow push fast close
- {128, 133},//undefined
- {134, 189},//slow close fast push
- {190, 195},//undefined
- {196, 250},//random strobe
- {251, 255},//undefined

The supported RDM PIDs are as follows:

DISC_UNIQUE_BRANCH
DISC_MUTE
DISC_UN_MUTE
DEVICE_INFO
DMX_START_ADDRESS
IDENTIFY_DEVICE
SOFTWARE_VERSION_LABEL
DMX_PERSONALITY
DMX_PERSONALITY_DESCRIPTION
SLOT_INFO
SLOT_DESCRIPTION
MANUFACTURER_LABEL
SUPPORTED_PARAMETERS

Restore to Factory Default Setting

Press and hold down both "Back" and "Enter" buttons until the digital display turns off, then release the buttons, system will reset and the digital display will turn on again, all settings will be restored to factory default.

Default settings are as follows:

DMX Address Code: a001
DMX Address Quantity: SW1=0: ch05, SW1=1:
ch04
PWM Resolution Mode: bt16
PWM Frequency: pf01
Gamma: ga1.5
Decoding Mode: dp1.1