

# STATIC COLOR LED NEON - 24V

Square Mini Profile / Top Bending / Silicone

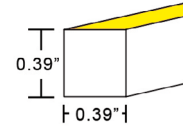
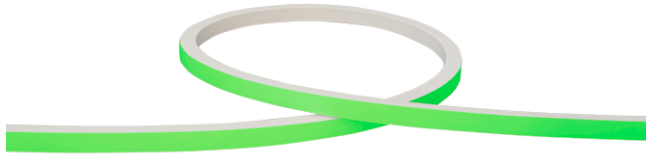

## TECHNICAL INFORMATION

NOTE: All data has +/- 5% tolerance.

WATTAGE	1.4W per foot
IP RATING	IP68 - wet locations. Protected against temporary submersion, limited protection against harsh environments.
PROFILE	Square Mini
BEND ORIENTATION	Top Bend
HOUSING MATERIAL	Silicone, UV resistant per ISO 4892-3
OUTPUT	Red (618-624nm) - 24 lm/ft Green (522-528nm) - 67 lm/ft Blue (468-474nm) - 15 lm/ft Amber (588-594nm) - 25 lm/ft
INPUT VOLTAGE	24VDC
SEGMENT LENGTH	Every 3.3", not field-cutable
MAXIMUM RUN	49 feet (single feed power)
DIMENSIONS	0.39" W x 0.39" H (10mm x 10mm)
MINIMUM BEND	3.9" diameter
INSTALLATION TEMP.	-40°F to 131°F
OPERATING TEMP.	-40°F to 131°F
WARRANTY	3 year limited
POWER SUPPLY	Compatible with all 24VDC power supplies – see power supply section of website

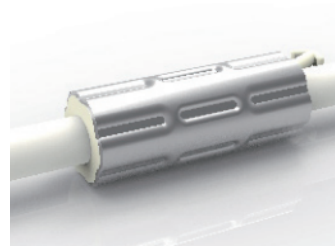

### ANTI-WICKING FERRULE

Standard on all LED Neon power cables. Located 4.5" from the connector. Protects against water ingress and circuit board corrosion. H 0.47" x W 1.18"

### MOUNTING OPTIONS:

See page 5 for mounting options. Aluminum extrusions and mounting clips are available (sold separately).

## PART NUMBER BUILDER / ORDERING GUIDE

Example part number: LLI-N1.4W-68-MTS-AMB-24V-96in

SERIES	IP RATING	TYPE	COLOR	VOLTAGE	LENGTH
LLI-N1.4W	68	MTS	<input type="text"/>	24V	<input type="text"/>
			<b>RED</b> - 24 lm/ft <b>GRN</b> - 67 lm/ft <b>BLU</b> - 15 lm/ft <b>AMB</b> - 25 lm/ft		(enter length in inches, up to 600")

# STATIC COLOR LED NEON - 24V

Square Mini Profile / Top Bending / Silicone

POWER FEED & TERMINATION OPTIONS (IP68)

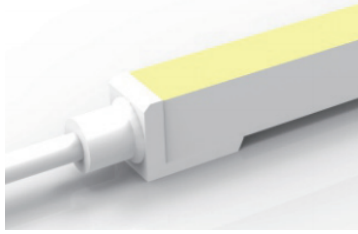

End Power Feed

SERIES	LENGTH
LLI-NM-68-PWR2-EF	39IN 118IN 196IN 393IN

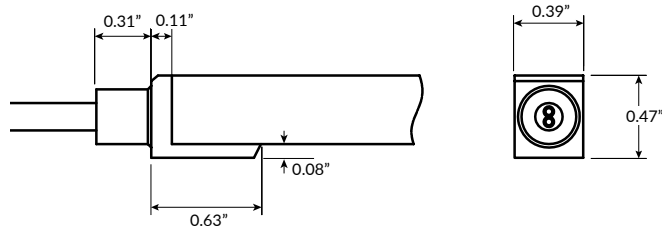

Rear Power Feed

SERIES	LENGTH
LLI-NM-68-PWR2-RF	39IN 118IN 196IN 393IN

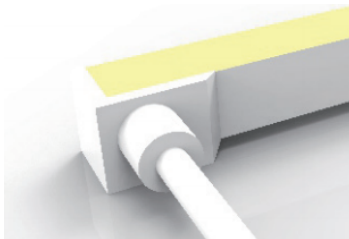
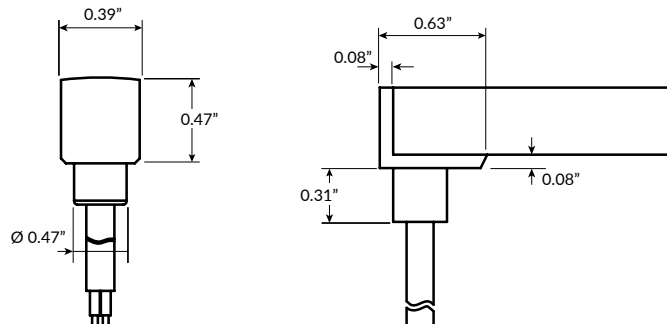

Side Right Power Feed

SERIES	SIDE	LENGTH
LLI-NM-68-PWR2	SR	39IN 118IN 196IN 393IN

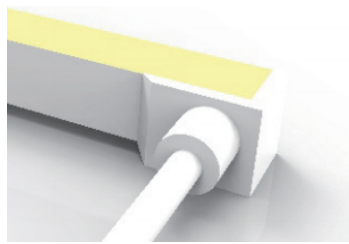

Side Left Power Feed

SERIES	SIDE	LENGTH
LLI-NM-68-PWR2	SL	39IN 118IN 196IN 393IN

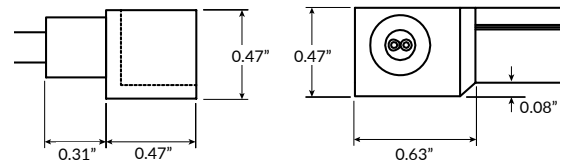

# STATIC COLOR LED NEON - 24V

Square Mini Profile / Top Bending / Silicone

POWER FEED & TERMINATION OPTIONS (IP68)

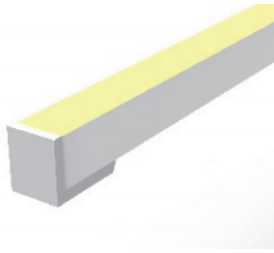

End Cap  
SERIES

LLI-NM-68-EC

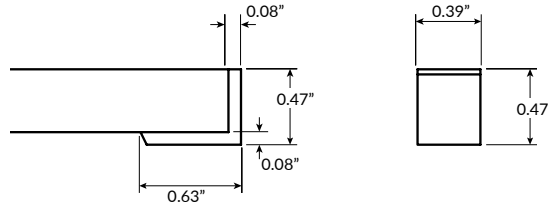

Jumper Power Connector (maximum 4 per run)

SERIES      SIDE      LENGTH (L)

LLI-NM-68-CON2

SR      12IN  
SL      39IN  
EF      118IN  
RF      196IN  
         393IN

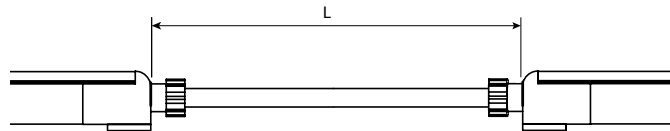

## OVERALL LENGTH / SEGMENT POINT GUIDE

Dimension tolerance of  $\pm 1/8"$ . Measurements listed below apply to Side Feed and Rear Feed Neon only. Add 1" to measurements below for End Feed Neon. Measurements below do not include area required for routing power wire. Add 1" distance to layout to account for routing end feed power wire. This product expands and contracts in varying ambient temperatures. If butting Neon end-to-end, add 1/2" to 1" gap between sections for expansion.

13.1"	16.4"	19.6"	23.0"	26.3"	29.5"	32.8"	36.0"	39.4"	42.6"	45.9"	49.3"
52.5"	55.8"	59.0"	62.4"	65.6"	68.9"	72.1"	75.4"	78.8"	82.0"	85.3"	88.5"
91.9"	95.1"	98.4"	101.6"	105.0"	108.3"	111.5"	114.8"	118.0"	121.4"	124.6"	127.9"
131.3"	134.5"	137.8"	141.0"	144.4"	147.6"	150.9"	154.1"	157.4"	160.8"	164.0"	167.3"
170.5"	173.9"	177.1"	180.4"	183.6"	187.0"	190.3"	193.5"	196.8"	200.0"	203.4"	206.6"
209.9"	213.3"	216.5"	219.8"	223.0"	226.4"	229.6"	232.9"	236.1"	239.4"	242.8"	246.0"
249.3"	252.5"	255.9"	259.1"	262.4"	265.6"	269.0"	272.3"	275.5"	278.8"	282.0"	285.4"
288.6"	291.9"	295.3"	298.5"	301.8"	305.0"	308.4"	311.6"	314.9"	318.1"	321.4"	324.8"
328.0"	331.3"	334.5"	337.9"	341.1"	344.4"	347.6"	351.0"	354.3"	357.5"	360.8"	364.0"
367.4"	370.6"	373.9"	377.3"	380.5"	383.8"	387.0"	390.3"	393.6"	396.9"	400.1"	403.4"
406.8"	410.0"	413.3"	416.5"	419.9"	423.1"	426.4"	429.6"	433.0"	436.3"	439.5"	442.8"
446.0"	449.4"	452.6"	455.9"	459.1"	462.5"	465.8"	469.0"	472.4"	475.6"	478.9"	482.1"
485.5"	488.8"	492.0"	495.3"	498.6"	501.9"	505.1"	508.4"	511.6"	515.0"	518.3"	521.5"
524.8"	528.0"	531.4"	534.6"	537.9"	541.3"	544.5"	547.8"	551.0"	554.4"	557.6"	560.9"
564.1"	567.4"	570.8"	574.0"	577.3"	580.6"	583.9"	587.1"	590.4"			

# STATIC WHITE LED NEON - 24V

Square Mini Profile / Top Bending / Silicone

## ORIENTATION & MINIMUM BEND DIAMETER

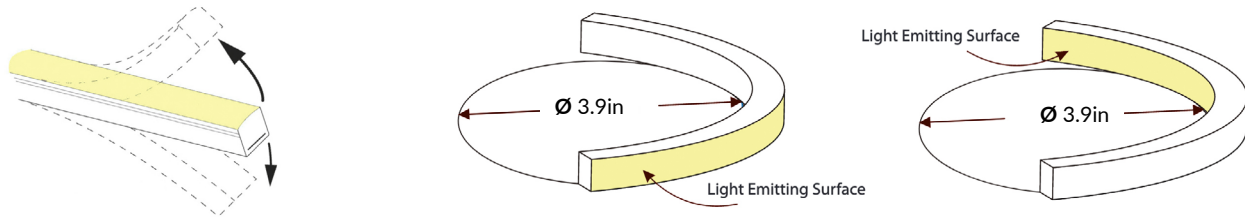

## POWER FEED ORIENTATION GUIDE

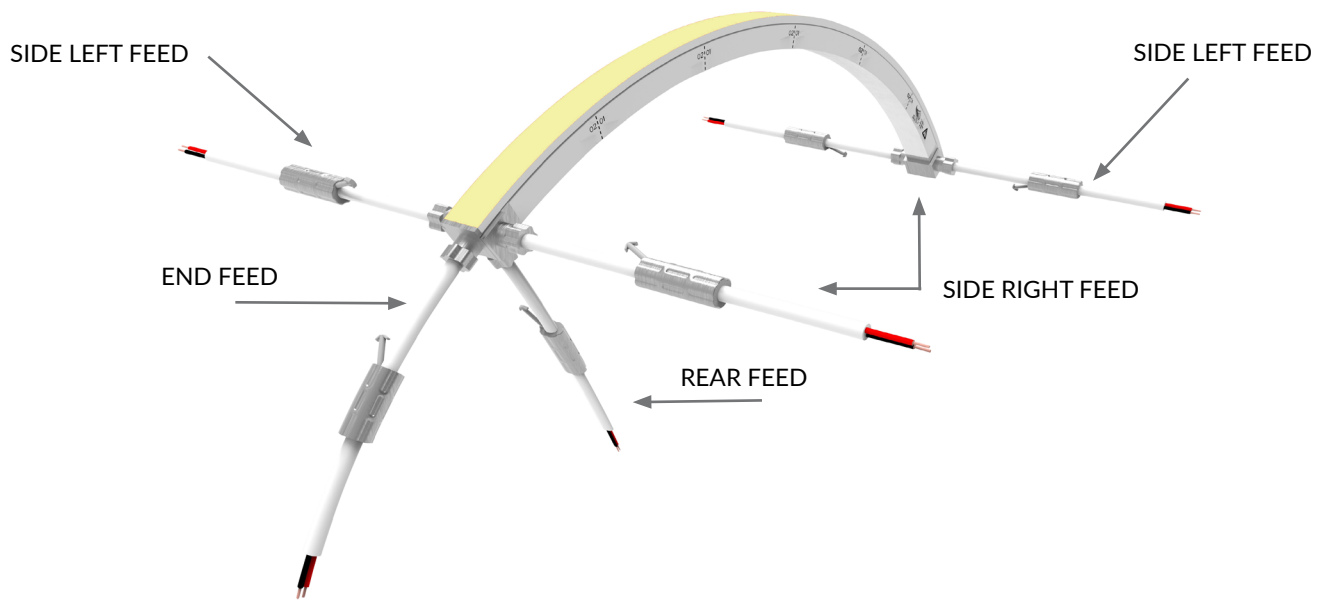

# STATIC WHITE LED NEON - 24V

Square Mini Profile / Top Bending / Silicone

## MOUNTING CHANNELS (SOLD SEPARATELY)

**NOTE:** Leave a 0.5" to 1" gap between Neon power feed and mounting channel, to avoid undue stress on power feed cables.

### ALUMINUM MOUNTING CHANNEL

Silver anodized finish

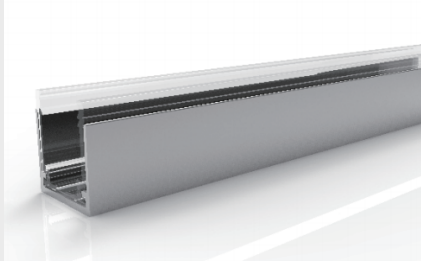

#### Mounting Clip

Part Number: LLI-NM-MCL-1.5IN

Dimensions: 1.38" L x 0.58" H x 0.55" W

Recommended use: 2 mounting clips for every 12in of LED Mini Neon.

#### 20" Mounting Channel

Part Number: LLI-NM-EXT-20IN

Dimensions: 20" L x 0.58" H x 0.55" W

#### 39" Mounting Channel

Part Number: LLI-NM-EXT-39IN

Dimensions: 39" L x 0.58" H x 0.55" W

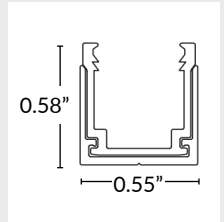

### ADJUSTABLE MOUNTING BRACKET

Recommended 3 brackets for every 39" channel

Adjusts in 15° increments, notches every 30°



Part Number: LLI-NM-BKT-ADJ

Dimensions: 1" L x 1.6" H x 1.8" W

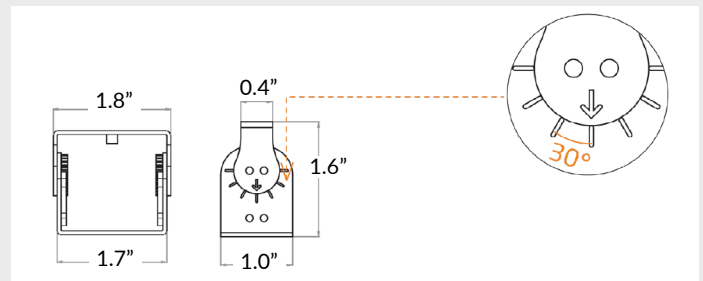

### SIDE MOUNTING BRACKET

Recommended 2 brackets for every 20" or 39" channel

Not compatible with mounting clips



Part Number: LLI-NM-BKT-90D

Dimensions: 0.8" L x 2.8" H x 1.0" W

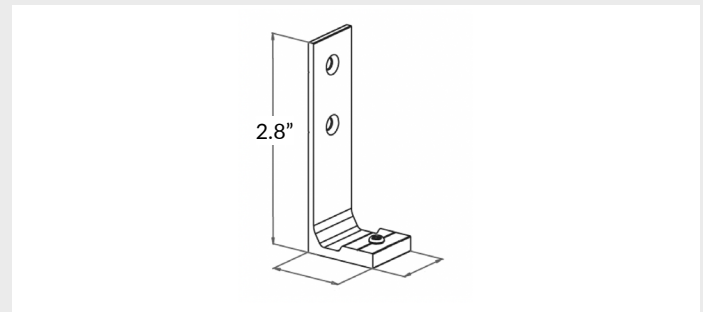

**POWER SUPPLIES** SOLD SEPARATELY

**DIMMABLE ELECTRONIC 0-10V**



Optimal performance dims to 0%.\*

PART NUMBER	CAPACITY	INPUT	OUTPUT	CLASS	LOCATION	L	W	H
LLI-PS-DE010-030W-24V-KO	30W	120V or 277V	24V	CLASS 2	IP66 WET	6.5"	3.6"	1.6"
LLI-PS-DE010-060W-24V-KO	60W	120V or 277V	24V	CLASS 2	IP66 WET	7.4"	3.6"	1.6"
LLI-PS-DE010-096W-24V-KO	96W	120V or 277V	24V	CLASS 2	IP66 WET	8.7"	3.7"	1.7"
LLI-PS-DE010-192W-24V-CL2-KO	2x96W	120V or 277V	24V	CLASS 2	IP66 WET	10.9"	4.3"	1.9"
LLI-PS-DE010-200W-24V-KO	200W	120V or 277V	24V	CLASS 1	IP66 WET	10.2"	4.1"	1.8"
LLI-PS-DE010-288W-24V-CL2-KO	3x96W	120V or 277V	24V	CLASS 2	IP66 WET	11.9"	4.3"	1.9"
LLI-PS-DE010-300W-24V-KO	300W	120V or 277V	24V	CLASS 1	IP66 WET	10.9"	4.3"	1.8"

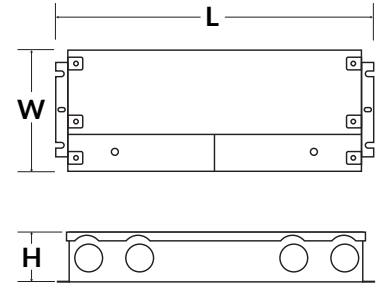

**NON-DIMMABLE ELECTRONIC**



PART NUMBER	CAPACITY	INPUT	OUTPUT	CLASS	LOCATION	L	W	H
LLI-PS-NDE-030W-24V-KO	30W	100-277V	24V	CLASS 2	IP66 WET	6.5"	3.5"	1.02"
LLI-PS-NDE-060W-24V-KO	60W	100-277V	24V	CLASS 2	IP66 WET	7.4"	3.5"	1.2"
LLI-PS-NDE-096W-24V-KO	96W	100-277V	24V	CLASS 2	IP66 WET	8.7"	3.7"	1.7"
LLI-PS-NDE-192W-24V-CL2-KO	2x96W	100-277V	24V	CLASS 2	IP66 WET	10.9"	4.1"	1.9"
LLI-PS-NDE-200W-24V-KO	200W	100-277V	24V	CLASS 1	IP66 WET	10.3"	4.1"	1.8"
LLI-PS-NDE-288W-24V-CL2-KO	3x96W	100-277V	24V	CLASS 2	IP66 WET	11.9"	4.1"	1.9"
LLI-PS-NDE-300W-24V-KO	300W	100-277V	24V	CLASS 1	IP66 WET	10.9"	4.3"	1.8"

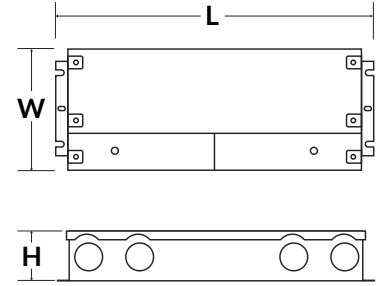

**DIMMABLE ELECTRONIC FLICKER-FREE**



Optimal performance dims to 2-5%.

PART NUMBER	CAPACITY	INPUT	OUTPUT	CLASS	LOCATION	L	W	H
LLI-PS-UDEFF-030W-24V-KO	30W	110-277V	24V	CLASS 2	IP66 WET	6.5"	3.6"	1.0"
LLI-PS-UDEFF-060W-24V-KO	60W	110-277V	24V	CLASS 2	IP66 WET	7.4"	3.6"	1.0"
LLI-PS-UDEFF-096W-24V-KO	96W	110-277V	24V	CLASS 2	IP66 WET	8.7"	3.7"	1.6"
LLI-PS-UDEFF-192W-24V-CL2-KO	2x96W	110-277V	24V	CLASS 2	IP66 WET	10.9"	4.3"	1.9"
LLI-PS-UDEFF-200W-24V-KO	200W	110-277V	24V	CLASS 1	IP66 WET	10.2"	4.1"	1.8"
LLI-PS-UDEFF-288W-24V-CL2-KO	3x96W	110-277V	24V	CLASS 2	IP66 WET	11.9"	4.3"	1.9"
LLI-PS-UDEFF-300W-24V-KO	300W	110-277V	24V	CLASS 1	IP66 WET	11.0"	4.3"	1.8"

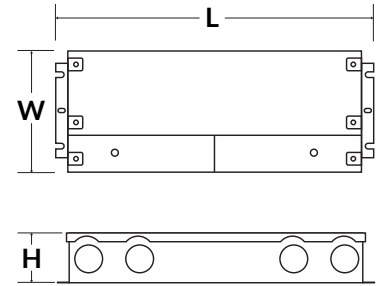

**DIMMABLE MAGNETIC**



Optimal performance dims to 5-10%.\*

PART NUMBER	CAPACITY	INPUT	OUTPUT	CLASS	LOCATION	L	W	H
LLI-PS-DM-020W-24V-KO	20W	120V or 277V	24V	CLASS 2	NEMA 3R WET	7.38"	2.11"	1.60"
LLI-PS-DM-040W-24V-KO	40W	120V or 277V	24V	CLASS 2	NEMA 3R WET	7.38"	2.11"	1.60"
LLI-PS-DM-060W-24V-KO	60W	120V or 277V	24V	CLASS 2	NEMA 3R WET	8.13"	3.93"	1.59"
LLI-PS-DM-100W-24V-KO	100W	120V or 277V	24V	CLASS 2	NEMA 3R WET	8.13"	3.93"	1.59"
LLI-PS-DM-150W-24V-KO	150W	120V or 277V	24V	CLASS 1	NEMA 3R WET	8.79"	4.15"	3.41"
LLI-PS-DM-200W-24V-KO	200W	120V or 277V	24V	CLASS 1	NEMA 3R WET	8.79"	4.15"	3.41"
LLI-PS-DM-300W-24V-KO	300W	120V or 277V	24V	CLASS 1	NEMA 3R WET	8.79"	4.15"	3.41"
LLI-PS-DM-300W-24V-CL2-KO	6 x 50W	120V or 277V	24V	CLASS 2	NEMA 3R WET	10.29"	5.69"	3.43"
LLI-PS-DM-600W-24V-KO	2 x 300W	120V or 277V	24V	CLASS 1	NEMA 3R WET	10.29"	6.79"	4.68"

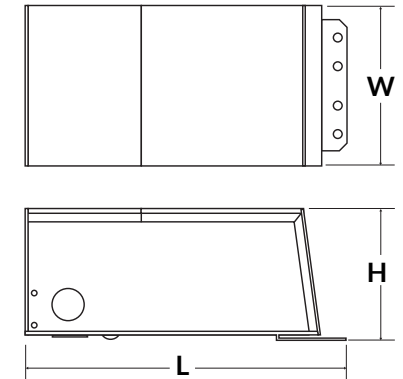

**LUTRON HI-LUME PREMIER 0.1% DIMMABLE ELECTRONIC**



Soft-on, Fade-to-Black, continuous flicker-free dimming from 100% to 0.1.

PART NUMBER	CAPACITY	INPUT	OUTPUT	CLASS	LOCATION	L	W	H
L3D0-96W24V-U	96W	120-277V	24V	CLASS 2	IP20 DRY	10.5"	5.5"	2.0"

