

LINE VOLTAGE STATIC BLUE/GREEN LED NEON - 120V

Dome Profile / Side Bending / PVC

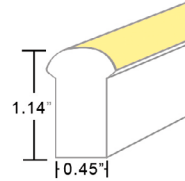
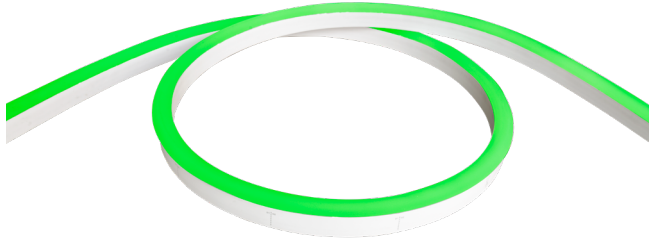

TECHNICAL INFORMATION

NOTE: All data has +/- 5% tolerance.

WATTAGE	3.1W per foot
BEND ORIENTATION	Side bend
IP RATING	IP65 - wet locations; not suitable for submersion, limited protection against harsh environments. Meets ETL 1598 standard.
HOUSING MATERIAL	PVC
OUTPUT	Blue 27 lm/ft Green 159 lm/ft
INPUT VOLTAGE	120VAC
SEGMENT LENGTH	Every 3.28", not field-cutttable
DIMMABLE	Yes, compatible with ELV reverse phase dimmers
MAXIMUM RUN	65ft max. run for individual section. 130ft max. run for two (2) 65ft sections joined by jumper cable. See pages 2-3. One (1) fuse box required per run, LLI-NAC-65-ETLBOX-12IN-120V
DIMENSIONS	0.45" W x 1.14" H (11.5mm x 29mm)
MINIMUM BEND	4.72" diameter
INSTALLATION TEMP.	4°F to 120°F
OPERATING TEMP.	-4°F to 120°F
WARRANTY	3 year limited

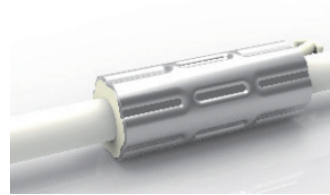

ANTI-WICKING FERRULE

Standard on all LED Neon power cables. Located 4.5" from the connector. Protects against water ingress and circuit board corrosion. H 0.47" x W 1.18"

MOUNTING CLIP OPTIONS (SOLD SEPARATELY)

More options and channels available (page 6-8). Recommended 2 clips per 12" of Neon.

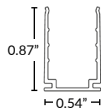

Mounting Clip

Part Number: LLI-ND-MCL-1.4IN
1.38" L x 0.87" H x 0.54" W

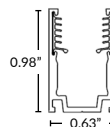

Silicone Grip Mounting Clip

Part Number: LLI-ND-MCL-SG-0.8IN
0.80" L x 0.98" H x 0.63" W

NOTE: Neon sections may be mounted end-to-end on the non-power feed end to create the appearance of longer runs. End-to-end Neon sections must have a 0.5" to 1" gap to allow for expansion/contraction. A dark spot may be visible at <20ft viewing distance.

PART NUMBER BUILDER / ORDERING GUIDE

Example part number: LLI-N3.1W-65-DSP-BLU-120V-96in

SERIES	IP RATING	TYPE	CCT	VOLTAGE	LENGTH
LLI-N3.1W	65	DSP		120V	
			BLU - 27 lm/ft GRN - 159 lm/ft		(enter length in inches, up to 780")

LINE VOLTAGE STATIC BLUE/GREEN LED NEON - 120V

Dome Profile / Side Bending / PVC

ORIENTATION & MINIMUM BEND DIAMETER

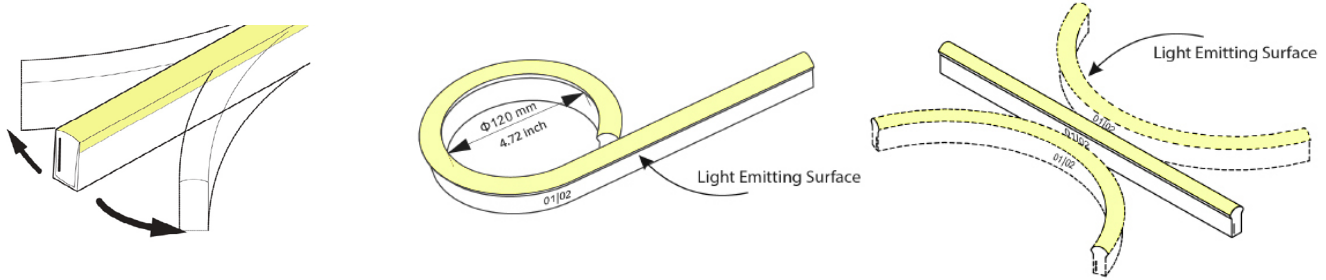

POWER FEED ORIENTATION GUIDE

All power feeds terminate in a male IP65 connector.

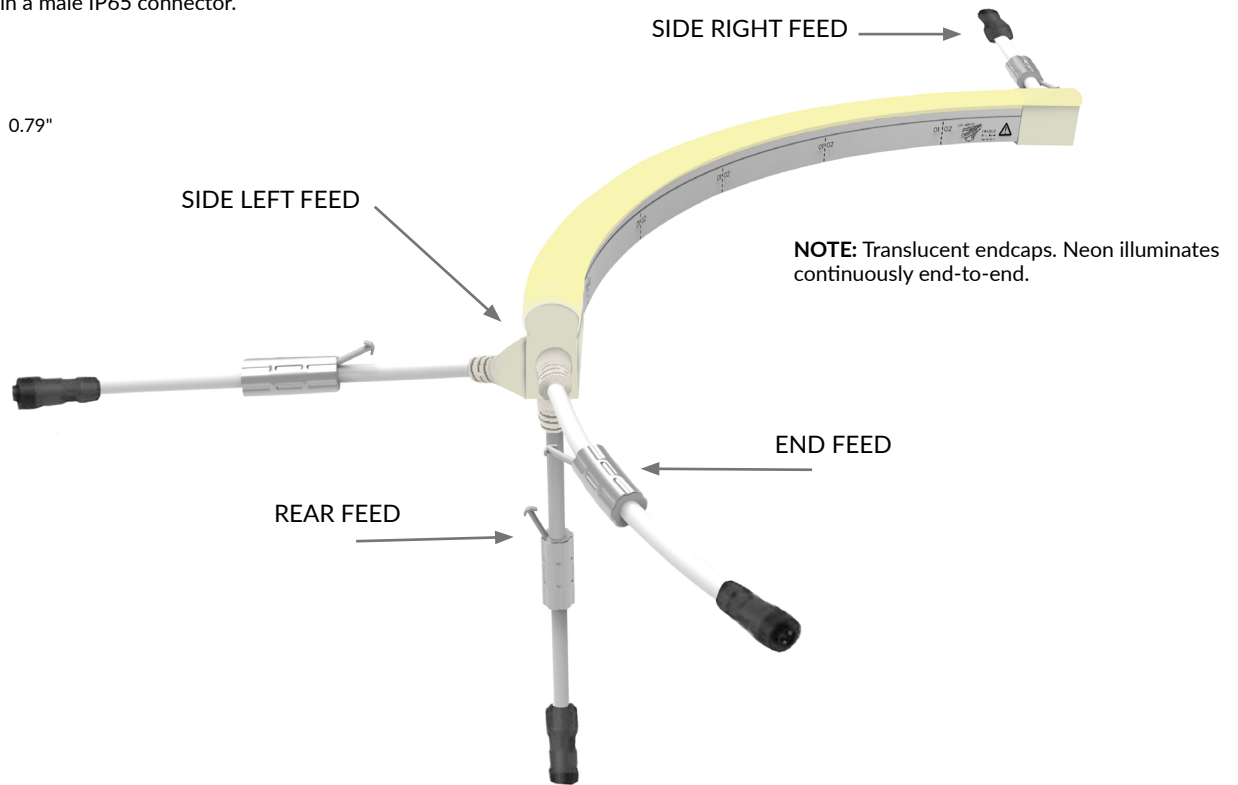
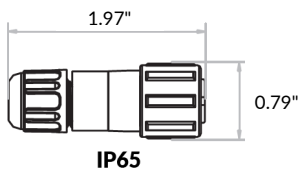

STANDARD LAYOUT



ETL Certified (Standard UL 1598, CSA C22.2#250.0)

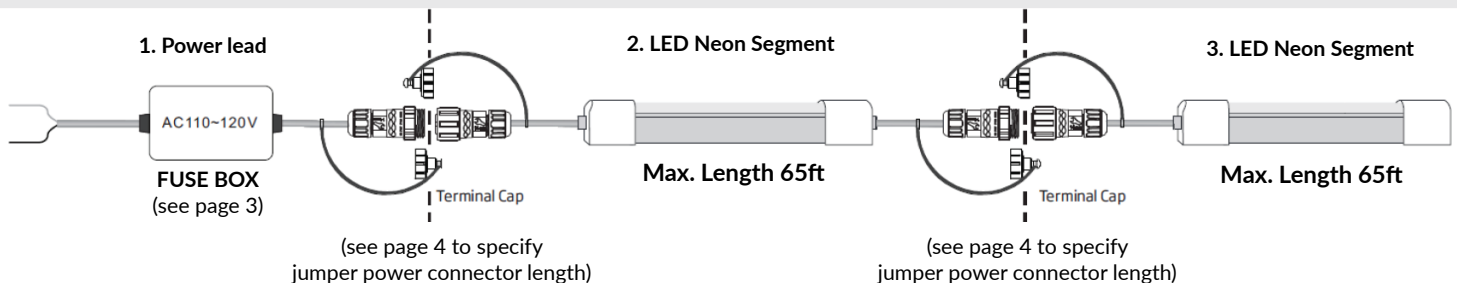

LINE VOLTAGE STATIC BLUE/GREEN LED NEON - 120V

Dome Profile / Side Bending / PVC

POWER FEED & TERMINATION OPTIONS (IP65)



Fuse Box

(required for every Neon section)

18AWG. 55" cable length before box; 12" cable length after box.

Box must be accessible for fuse replacement.

Do not open fuse box during installation or during use.

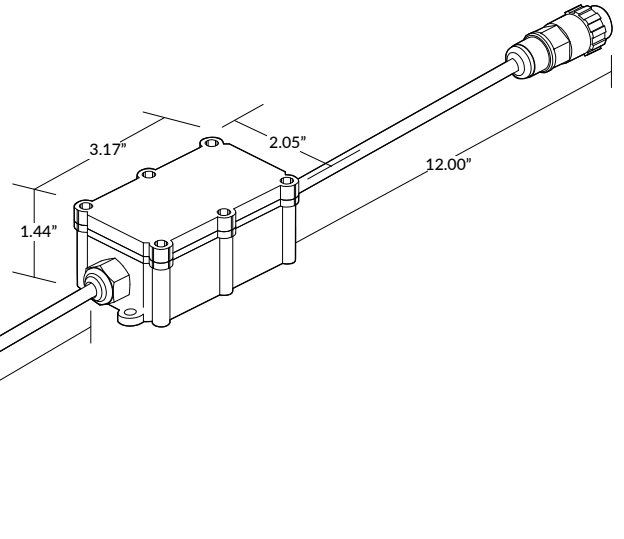

SERIES	LENGTH	INPUT
LLI-NAC-65-ETLBOX	12IN	120V

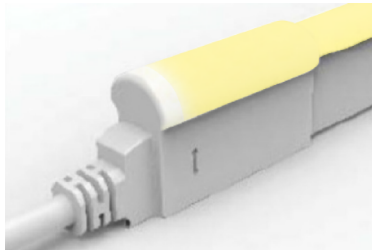

End Power Feed

SERIES	SIDE	LENGTH	INPUT
LLI-ND-65-PWR2	EF		120V

39IN
118IN
196IN
393IN

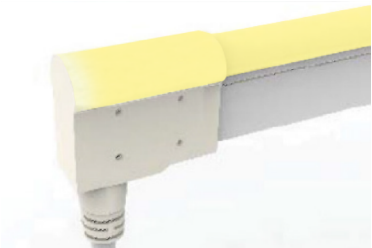
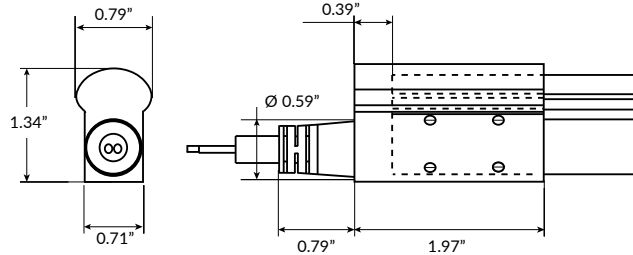

Rear Power Feed

SERIES	SIDE	LENGTH	INPUT
LLI-ND-65-PWR2	RF		120V

39IN
118IN
196IN
393IN

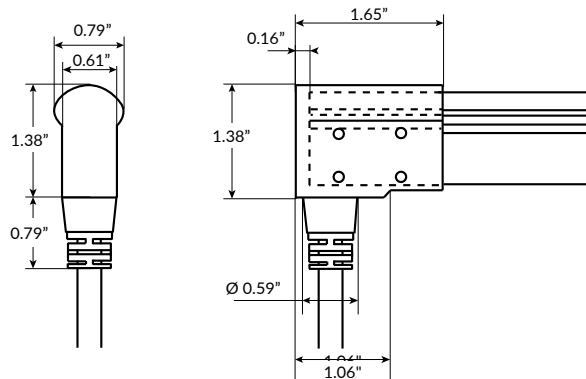

LINE VOLTAGE STATIC BLUE/GREEN LED NEON - 120V

Dome Profile / Side Bending / PVC

POWER FEED & TERMINATION OPTIONS (IP65)

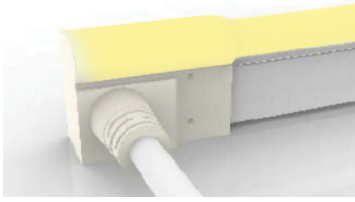

Side Right Power Feed

SERIES	SIDE	LENGTH	INPUT
LLI-ND-65-PWR2	SR	39IN 118IN 196IN 393IN	120V

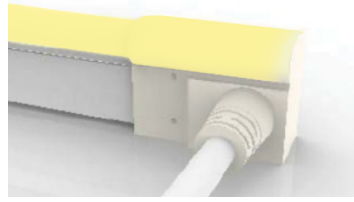

Side Left Power Feed

SERIES	SIDE	LENGTH	INPUT
LLI-ND-65-PWR2	SL	39IN 118IN 196IN 393IN	120V

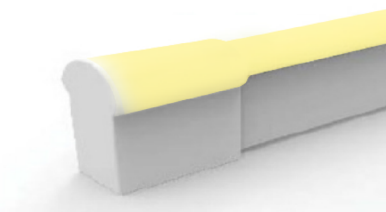
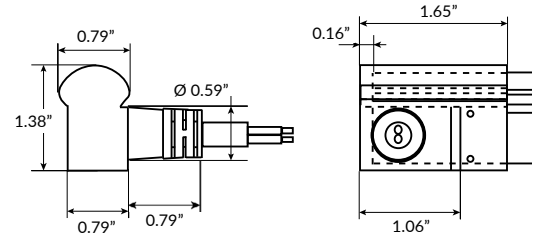

End Cap

SERIES
LLI-ND-65-EC-120V

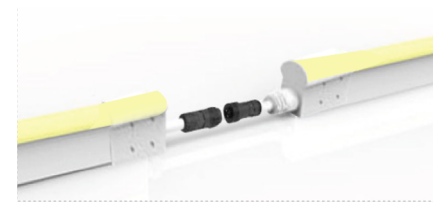
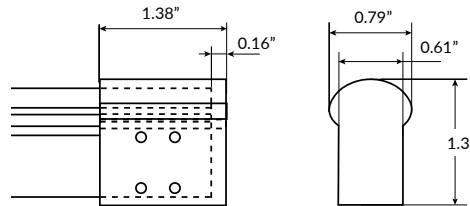

Jumper Power Connector

SERIES	SIDE	LENGTH (L)
LLI-ND-65-CON2	—	—
	SR	12IN
	SL	39IN
	EF	118IN
	RF	196IN 393IN

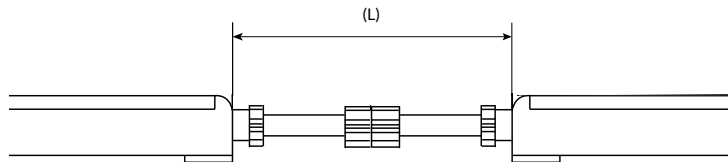

LINE VOLTAGE STATIC BLUE/GREEN LED NEON - 120V

Dome Profile / Side Bending / PVC

OVERALL LENGTH / CUT POINT GUIDE

Dimension tolerance of $\pm 1/8"$.

This product expands and contracts in varying ambient temperatures. If butting Neon end-to-end, add 1/2" to 1" gap between sections for expansion.

SIDE FEED AND REAR FEED LED NEON

3.6"	6.9"	10.2"	13.4"	16.7"	20.0"	23.3"	26.6"	29.8"	33.1"	36.4"	39.7"
43.0"	46.2"	49.5"	52.8"	56.1"	59.4"	62.6"	65.9"	69.2"	72.5"	75.8"	79.0"
82.3"	85.6"	88.9"	92.2"	95.4"	98.7"	102.0"	105.3"	108.6"	111.8"	115.1"	118.4"
121.7"	125.0"	128.2"	131.5"	134.8"	138.1"	141.4"	144.6"	147.9"	151.2"	154.5"	157.8"
161.0"	164.3"	167.6"	170.9"	174.2"	177.4"	180.7"	184.0"	187.3"	190.6"	193.8"	197.1"
200.4"	203.7"	207.0"	210.2"	213.5"	216.8"	220.1"	223.4"	226.6"	229.9"	233.2"	236.5"
239.8"	243.0"	246.3"	249.6"	252.9"	256.2"	259.4"	262.7"	266.0"	269.3"	272.6"	275.8"
279.1"	282.4"	285.7"	289.0"	292.2"	295.5"	298.8"	302.1"	305.4"	308.6"	311.9"	315.2"
318.5"	321.8"	325.0"	328.3"	331.6"	334.9"	338.2"	341.4"	344.7"	348.0"	351.3"	354.6"
357.8"	361.1"	364.4"	367.7"	371.0"	374.2"	377.5"	380.8"	384.1"	387.4"	390.6"	393.9"
397.2"	400.5"	403.8"	407.0"	410.3"	413.6"	416.9"	420.2"	423.4"	426.7"	430.0"	433.3"
436.6"	439.8"	443.1"	446.4"	449.7"	453.0"	456.2"	459.5"	462.8"	466.1"	469.4"	472.6"
475.9"	479.2"	482.5"	485.8"	489.0"	492.3"	495.6"	498.9"	502.2"	505.4"	508.7"	512.0"
515.3"	518.6"	521.8"	525.1"	528.4"	531.7"	535.0"	538.2"	541.5"	544.8"	548.1"	551.4"
554.6"	557.9"	561.2"	564.5"	567.8"	571.0"	574.3"	577.6"	580.9"	584.2"	587.4"	590.7"
594.0"	597.3"	600.6"	603.8"	607.1"	610.4"	613.7"	617.0"	620.2"	623.5"	626.8"	630.1"
633.4"	636.6"	639.9"	643.2"	646.5"	649.8"	653.0"	656.3"	659.6"	662.9"	666.2"	669.4"
672.7"	676.0"	679.3"	682.6"	685.8"	689.1"	692.4"	695.7"	699.0"	702.2"	705.5"	708.8"
712.1"	715.4"	718.6"	721.9"	725.2"	728.5"	731.8"	735.0"	738.3"	741.6"	744.9"	748.2"
751.4"	754.7"	758.0"	761.3"	764.6"	767.8"	771.1"	774.4"	777.7"			

END FEED LED NEON

Measurement does not include area required for routing power wire. Add 1.5" distance account for routing end feed power wire.

4.5"	7.7"	11.0"	14.3"	17.6"	20.9"	24.1"	27.4"	30.7"	34.0"	37.3"	40.5"
43.8"	47.1"	50.4"	53.7"	56.9"	60.2"	63.5"	66.8"	70.1"	73.3"	76.6"	79.9"
83.2"	86.5"	89.7"	93.0"	96.3"	99.6"	102.9"	106.1"	109.4"	112.7"	116.0"	119.3"
122.5"	125.8"	129.1"	132.4"	135.7"	138.9"	142.2"	145.5"	148.8"	152.1"	155.3"	158.6"
161.9"	165.2"	168.5"	171.7"	175.0"	178.3"	181.6"	184.9"	188.1"	191.4"	194.7"	198.0"
201.3"	204.5"	207.8"	211.1"	214.4"	217.7"	220.9"	224.2"	227.5"	230.8"	234.1"	237.3"
240.6"	243.9"	247.2"	250.5"	253.7"	257.0"	260.3"	263.6"	266.9"	270.1"	273.4"	276.7"
280.0"	283.3"	286.5"	289.8"	293.1"	296.4"	299.7"	302.9"	306.2"	309.5"	312.8"	316.1"
319.3"	322.6"	325.9"	329.2"	332.5"	335.7"	339.0"	342.3"	345.6"	348.9"	352.1"	355.4"
358.7"	362.0"	365.3"	368.5"	371.8"	375.1"	378.4"	381.7"	384.9"	388.2"	391.5"	394.8"
398.1"	401.3"	404.6"	407.9"	411.2"	414.5"	417.7"	421.0"	424.3"	427.6"	430.9"	434.1"
437.4"	440.7"	444.0"	447.3"	450.5"	453.8"	457.1"	460.4"	463.7"	466.9"	470.2"	473.5"
476.8"	480.1"	483.3"	486.6"	489.9"	493.2"	496.5"	499.7"	503.0"	506.3"	509.6"	512.9"
516.1"	519.4"	522.7"	526.0"	529.3"	532.5"	535.8"	539.1"	542.4"	545.7"	548.9"	552.2"
555.5"	558.8"	562.1"	565.3"	568.6"	571.9"	575.2"	578.5"	581.7"	585.0"	588.3"	591.6"
594.9"	598.1"	601.4"	604.7"	608.0"	611.3"	614.5"	617.8"	621.1"	624.4"	627.7"	630.9"
634.2"	637.5"	640.8"	644.1"	647.3"	650.6"	653.9"	657.2"	660.5"	663.7"	667.0"	670.3"
673.6"	676.9"	680.1"	683.4"	686.7"	690.0"	693.3"	696.5"	699.8"	703.1"	706.4"	709.7"
712.9"	716.2"	719.5"	722.8"	726.1"	729.3"	732.6"	735.9"	739.2"	742.5"	745.7"	749.0"
752.3"	755.6"	758.9"	762.1"	765.4"	768.7"	772.0"	775.3"	778.5"			

LINE VOLTAGE STATIC BLUE/GREEN LED NEON - 120V

Dome Profile / Side Bending / PVC

MOUNTING CHANNELS

NOTE: Leave a 0.5" to 1" gap between Neon power feed and mounting channel, to avoid undue stress on power feed cables.

ALUMINUM MOUNTING CHANNEL

Silver anodized finish

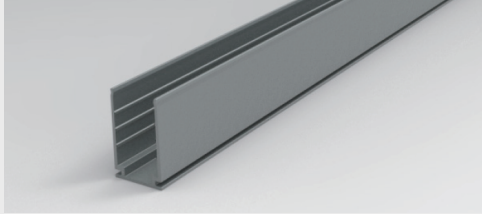

Mounting Clip

Recommended 2 clips every 12"

Part Number: LLI-ND-MCL-1.4IN

Dimensions: 1.38" L x 0.87" H x 0.54" W

20" Mounting Channel

Part Number: LLI-ND-EXT-20IN

Dimensions: 20" L x 0.87" H x 0.54" W

39" Mounting Channel

Part Number: LLI-ND-EXT-39IN

Dimensions: 39" L x 0.87" H x 0.54" W

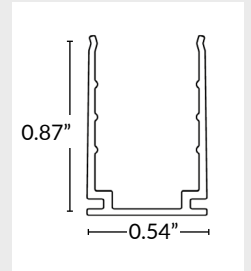

SILICONE GRIP ALUMINUM MOUNTING CHANNEL

Recommended for ceiling and wall applications

Silver anodized finish

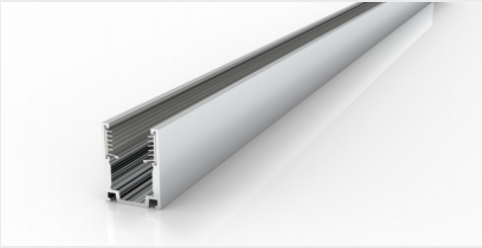

Mounting Clip

Recommended 2 clips every 12"

Part Number: LLI-ND-MCL-SG-0.8IN

Dimensions: 0.80" L x 0.98" H x 0.63" W

20" Mounting Channel

Part Number: LLI-ND-EXT-SG-20IN

Dimensions: 20" L x 0.98" H x 0.63" W

39" Mounting Channel

Part Number: LLI-ND-EXT-SG-39IN

Dimensions: 39.4" L x 0.98" H x 0.63" W

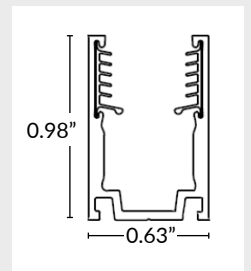

PLASTIC MOUNTING CHANNEL

White finish



20" Mounting Channel

Part Number: LLI-NS-EXT-P-20IN

Dimensions: 20" L x 0.94" H x 0.55" W

39" Mounting Channel

Part Number: LLI-NS-EXT-P-39IN

Dimensions: 39.4" L x 0.94" H x 0.55" W

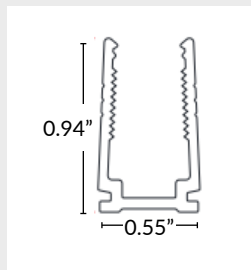

REINFORCED PLASTIC MOUNTING CHANNEL

Clear plastic



1.4" Mounting Clip

Part Number: LLI-ND-EXT-CP-1.4IN

Dimensions: 1.38" L x 1.03" H x 0.62" W

20" Mounting Channel

Part Number: LLI-ND-EXT-CP-20IN

Dimensions: 20" L x 1.03" H x 0.62" W

39" Mounting Channel

Part Number: LLI-ND-EXT-CP-39IN

Dimensions: 39.4" L x 1.03" H x 0.62" W

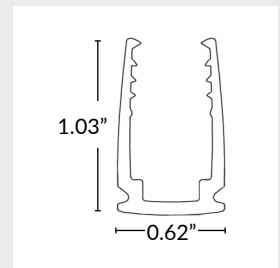

LINE VOLTAGE STATIC BLUE/GREEN LED NEON - 120V

Dome Profile / Side Bending / PVC

MOUNTING CHANNELS (CONTINUED)

NOTE: Leave a 0.5" to 1" gap between Neon power feed and mounting channel, to avoid undue stress on power feed cables.

FLEXIBLE SILICONE GRIP ALUMINUM MOUNTING CHANNEL

Silver anodized finish

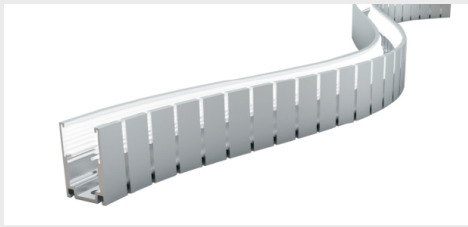

20" Mounting Channel

Part Number: LLI-ND-EXT-FSG-20IN
Dimensions: 20" L x 0.98" H x 0.63" W

39" Mounting Channel

Part Number: LLI-ND-EXT-FSG-39IN
Dimensions: 39.4" L x 0.98" H x 0.63" W

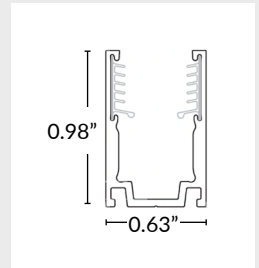

RECESSED ALUMINUM MOUNTING CHANNEL

Silver anodized finish



0.8" Mounting Clip

Part Number: LLI-ND-EXT-R-0.8IN
Dimensions: 0.8" L x 0.94" H x 0.79" W

20" Mounting Channel

Part Number: LLI-ND-EXT-R-20IN
Dimensions: 20" L x 0.94" H x 0.79" W

39" Mounting Channel

Part Number: LLI-ND-EXT-R-39IN
Dimensions: 39.4" L x 0.94" H x 0.79" W

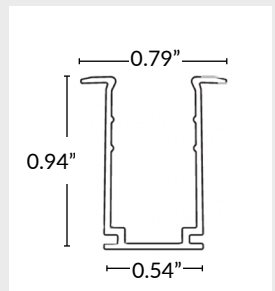

RECESSED ALUMINUM MOUNTING CHANNEL WITH SILICONE GRIP

Recommended for ceiling and wall applications
Silver anodized finish



0.8" Mounting Clip

Part Number: LLI-ND-MCL-RSG-0.8IN
Dimensions: 0.8" L x 0.98" H x 1.0" W

20" Mounting Channel

Part Number: LLI-ND-EXT-RSG-20IN
Dimensions: 20" L x 0.98" H x 1.0" W

39" Mounting Channel

Part Number: LLI-ND-EXT-RSG-39IN
Dimensions: 39.4" L x 0.98" H x 1.0" W

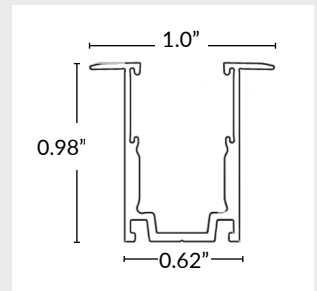

ADJUSTABLE MOUNTING BRACKET

Recommended 3 brackets for every 39" channel
Adjusts in 15° increments, notches every 30°



Part Number: LLI-ND-BKT-ADJ
Dimensions: 1" L x 1.6" H x 1.8" W

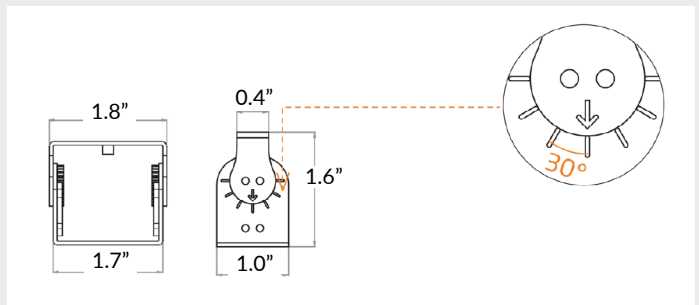

LINE VOLTAGE STATIC BLUE/GREEN LED NEON - 120V

Dome Profile / Side Bending / PVC

MOUNTING CHANNELS (CONTINUED)

NOTE: Leave a 0.5" to 1" gap between Neon power feed and mounting channel, to avoid undue stress on power feed cables.

SIDE MOUNTING BRACKET

Recommended 2 brackets for every 20" or 39" channel

Not compatible with mounting clips



Part Number: LLI-ND-BKT-90D
Dimensions: 0.8" L x 2.8" H x 1.0" W

