

LINE VOLTAGE STATIC RED/AMBER LED NEON - 120V

Square Profile / Top Bending / PVC

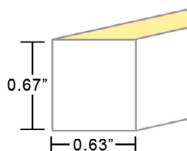
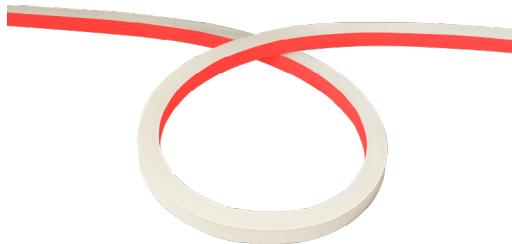

TECHNICAL INFORMATION

NOTE: All data has +/- 5% tolerance.

WATTAGE	3.1W per foot
IP RATING	IP65 - wet locations. Not suitable for submersion, limited protection against harsh environments.
PROFILE	Square
BEND ORIENTATION	Top Bending
HOUSING MATERIAL	PVC
OUTPUT	Red (620-630nm) 79 lm/ft Amber (585-595nm) 79 lm/ft
INPUT VOLTAGE	120VAC
SEGMENT LENGTH	Every 4.92", not field-cuttable
MAXIMUM RUN	65ft max. run for individual section. 130ft max. run for two (2) 65ft sections joined by jumper cable. See pages 2-3. One (1) fuse box required per run, LLI-NAC-65-ETLBOX-12IN-120V
DIMENSIONS	0.63" W x 0.67" H (16mm x 17mm)
MINIMUM BEND	12" diameter
INSTALLATION TEMP.	32°F to 140°F (do not install when temperatures are below freezing)
OPERATING TEMP.	-13°F to 140°F
WARRANTY	3 year limited

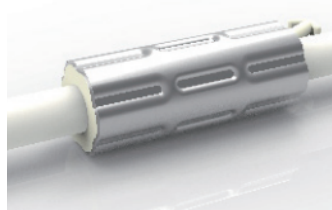

ANTI-WICKING FERRULE

Standard on all LED Neon power cables. Located 4.5" from the connector. Protects against water ingress and circuit board corrosion.
H 0.47" x W 1.18"

MOUNTING OPTIONS (SOLD SEPARATELY)

More clips and channel options available (see page 6-7).

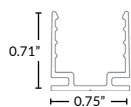

Mounting Clip

Part Number: LLI-NS-MCL-1.5IN
1.38" L x 0.71" H x 0.75" W

Recommended: 2 mounting clips for every 12in of Neon.

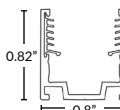

Silicone Grip Mounting Clip

Part Number: LLI-NS-MCL-SG-0.8IN
0.8" L x 0.82" H x 0.8" W

Recommended: 2 mounting clips for every 12in of Neon.

NOTE: Neon sections may be mounted end-to-end on the non-power feed end to create the appearance of longer runs. End-to-end Neon sections must have a 0.5" to 1" gap to allow for expansion/contraction. A dark spot may be visible at <20ft viewing distance.

PART NUMBER BUILDER / ORDERING GUIDE

Example part number: LLI-N3.1W-65-STP-22K-120V-96in

SERIES	IP RATING	TYPE	COLOR	VOLTAGE	LENGTH
LLI-N3.1W	65	STP	<input type="text"/>	120V	<input type="text"/>
			RED - 27 lm/ft AMB - 27 lm/ft		(enter length in inches, up to 780")

LINE VOLTAGE STATIC RED/AMBER LED NEON - 120V

Square Profile / Top Bending / PVC

ORIENTATION & MINIMUM BEND DIAMETER

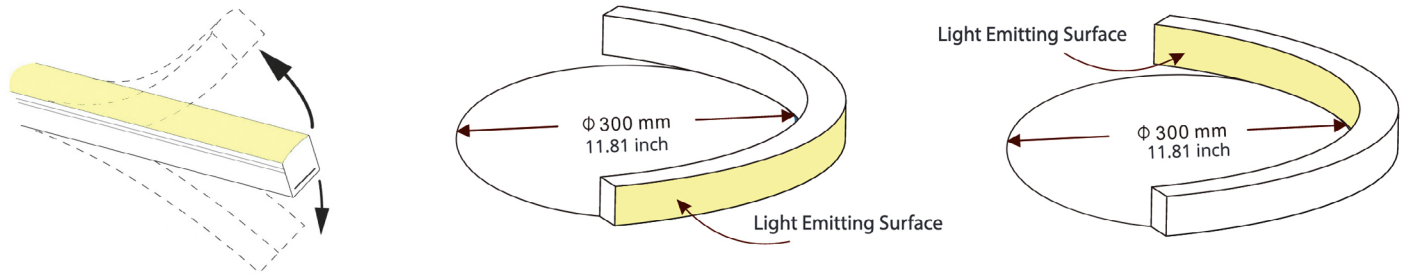

POWER FEED ORIENTATION GUIDE

All power feeds terminate in a male IP65 connector.

NOTE: Translucent endcaps. Neon endcaps will illuminate.

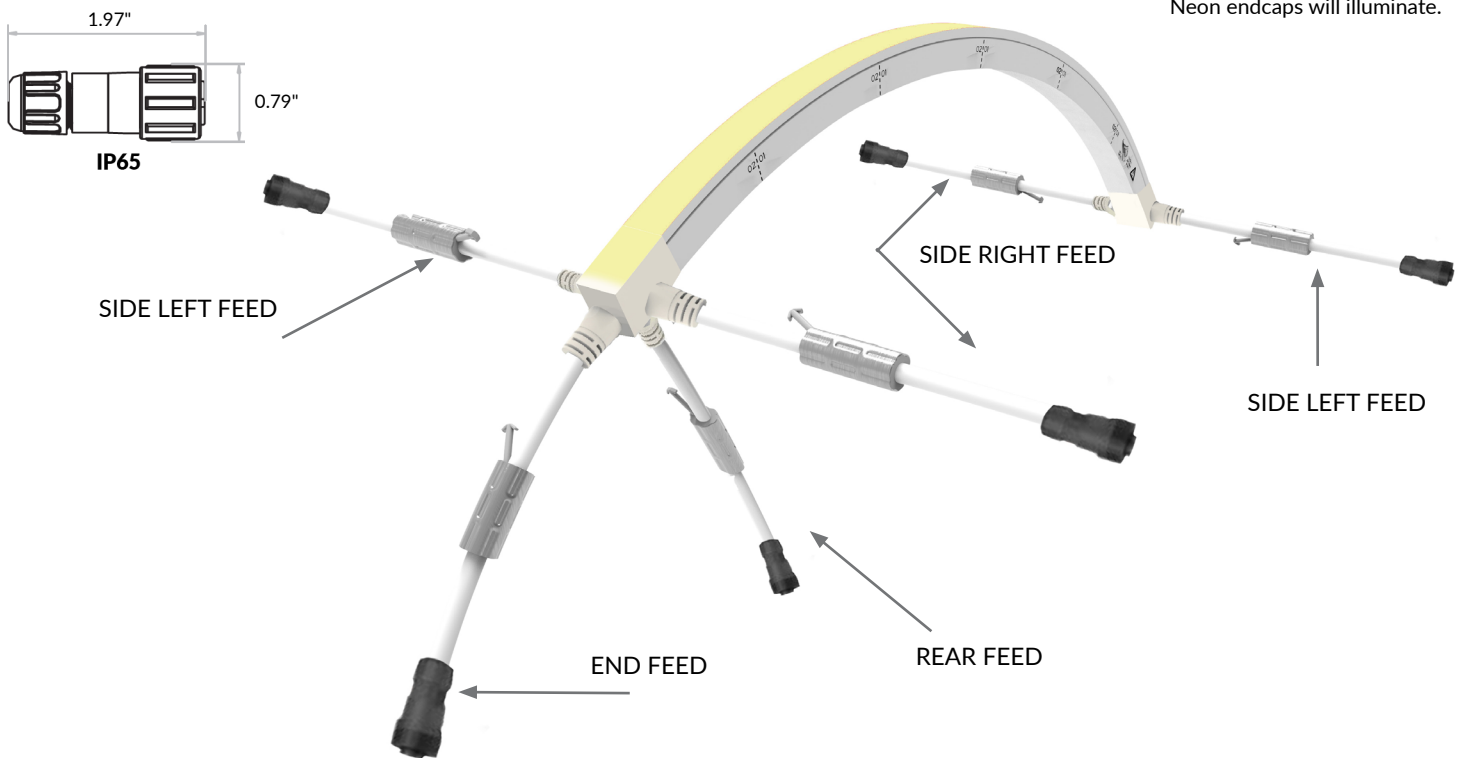

STANDARD LAYOUT



ETL Certified (Standard UL 1598, CSA C22.2#250.0)

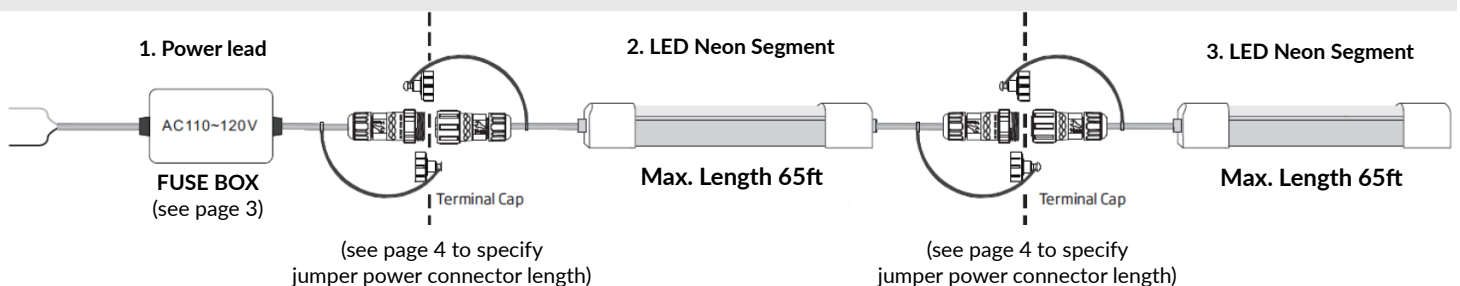

LINE VOLTAGE STATIC RED/AMBER LED NEON - 120V

Square Profile / Top Bending / PVC

POWER FEED & TERMINATION OPTIONS (IP65)



Fuse Box

(required for every Neon section)

18AWG. 55" cable length before box; 12" cable length after box.
Box must be accessible for fuse replacement.

Do not open fuse box during installation or during use.

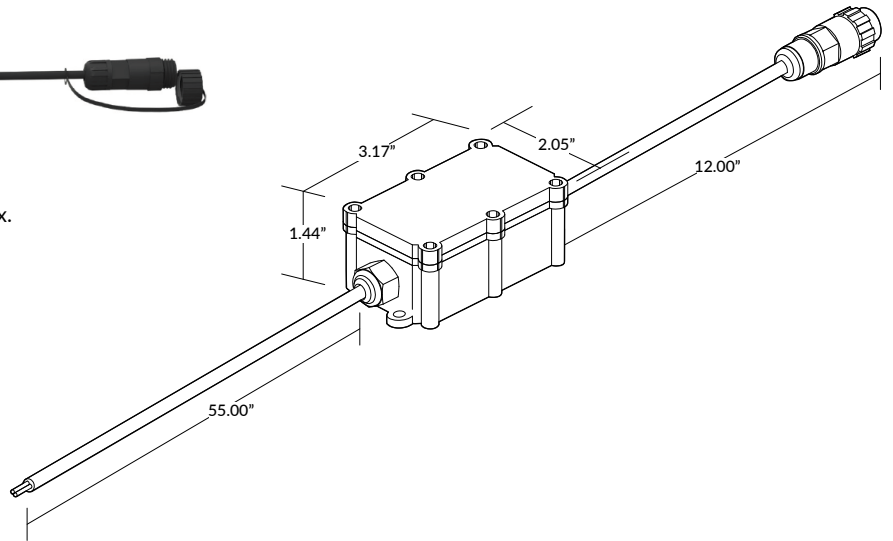

SERIES	LENGTH	INPUT
LLI-NAC-65-ETLBOX	12IN	120V

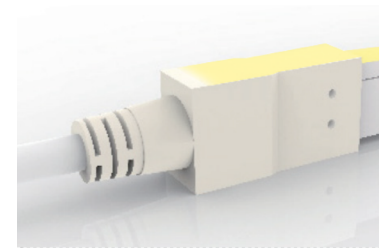

End Power Feed

SERIES	LENGTH	INPUT
LLI-NS-65-PWR2-EF	39IN 118IN 196IN 393IN	120V

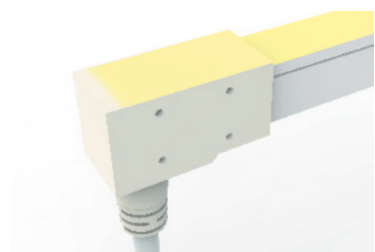
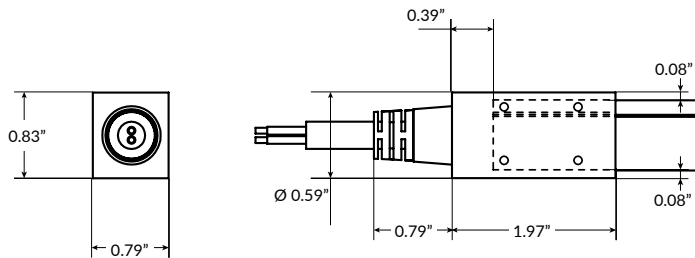

Rear Power Feed

SERIES	LENGTH	INPUT
LLI-NS-65-PWR2-RF	39IN 118IN 196IN 393IN	120V

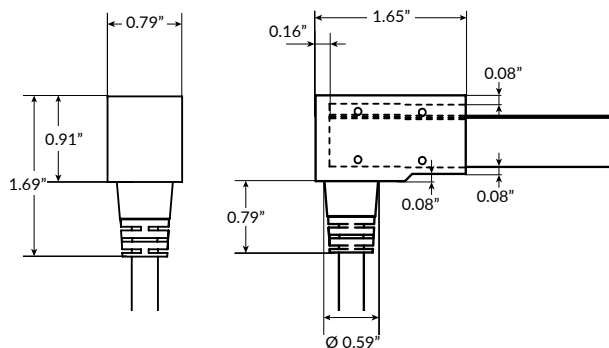

LINE VOLTAGE STATIC RED/AMBER LED NEON - 120V

Square Profile / Top Bending / PVC

POWER FEED & TERMINATION OPTIONS (IP67)

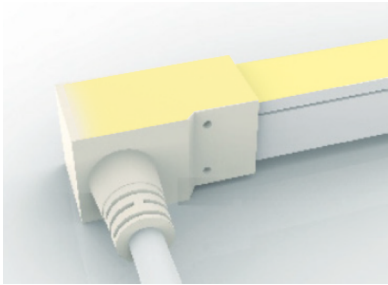

Side Right Power Feed

SERIES	SIDE	LENGTH	INPUT
LLI-NS-65-PWR2	SR	39IN 118IN 196IN 393IN	120V

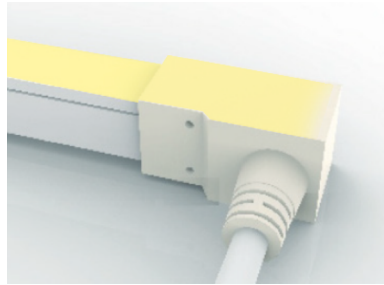

Side Left Power Feed

SERIES	SIDE	LENGTH	INPUT
LLI-NS-65-PWR2	SL	39IN 118IN 196IN 393IN	120V

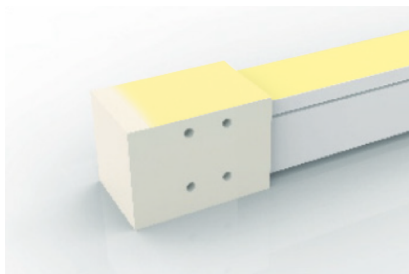
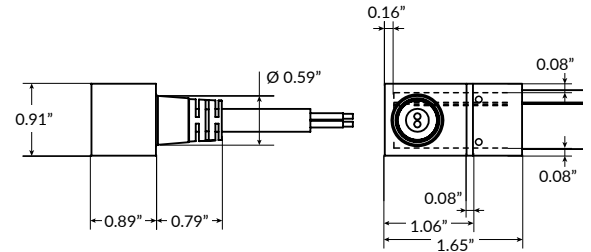

End Cap

SERIES	INPUT
LLI-NS-65-EC	120V

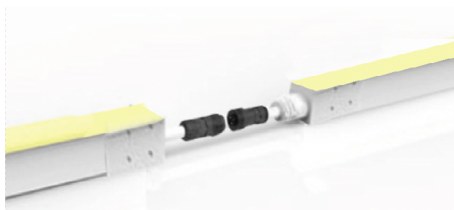
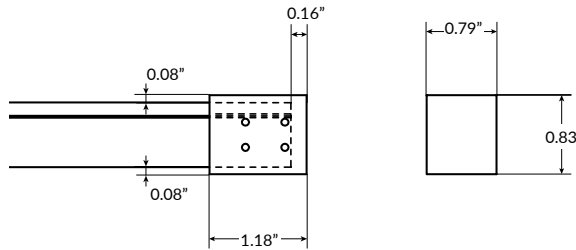

Jumper Power Connector

SERIES	SIDE	LENGTH (L)	INPUT
LLI-NS-65-CON2	SR SL EF RF	12IN 39IN 118IN 196IN 393IN	120V

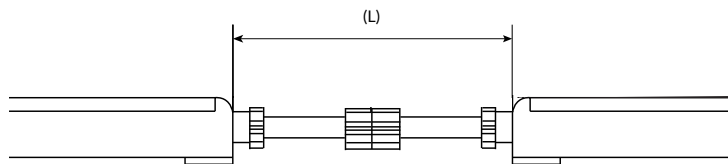

LINE VOLTAGE STATIC RED/AMBER LED NEON - 120V

Square Profile / Top Bending / PVC

OVERALL LENGTH / CUT POINT GUIDE

Dimension tolerance of $\pm 1/8"$.

This product expands and contracts in varying ambient temperatures. If butting Neon end-to-end, add 1/2" to 1" gap between sections for expansion.

SIDE FEED AND REAR FEED LED NEON

5.2"	10.2"	15.1"	20.0"	24.9"	29.8"	34.8"	39.7"	44.6"	49.5"	54.4"	59.4"
64.3"	69.2"	74.1"	79.0"	84.0"	88.9"	93.8"	98.7"	103.6"	108.6"	113.5"	118.4"
123.3"	128.2"	133.2"	138.1"	143.0"	147.9"	152.8"	157.8"	162.7"	167.6"	172.5"	177.4"
182.4"	187.3"	192.2"	197.1"	202.0"	207.0"	211.9"	216.8"	221.7"	226.6"	231.6"	236.5"
241.4"	246.3"	251.2"	256.2"	261.1"	266.0"	270.9"	275.8"	280.8"	285.7"	290.6"	295.5"
300.4"	305.4"	310.3"	315.2"	320.1"	325.0"	330.0"	334.9"	339.8"	344.7"	349.6"	354.6"
359.5"	364.4"	369.3"	374.2"	379.2"	384.1"	389.0"	393.9"	398.8"	403.8"	408.7"	413.6"
418.5"	423.4"	428.4"	433.3"	438.2"	443.1"	448.0"	453.0"	457.9"	462.8"	467.7"	472.6"
477.6"	482.5"	487.4"	492.3"	497.2"	502.2"	507.1"	512.0"	516.9"	521.8"	526.8"	531.7"
536.6"	541.5"	546.4"	551.4"	556.3"	561.2"	566.1"	571.0"	576.0"	580.9"	585.8"	590.7"
595.6"	600.6"	605.5"	610.4"	615.3"	620.2"	625.2"	630.1"	635.0"	639.9"	644.8"	649.8"
654.7"	659.6"	664.5"	669.4"	674.4"	679.3"	684.2"	689.1"	694.0"	699.0"	703.9"	708.8"
713.7"	718.6"	723.6"	728.5"	733.4"	738.3"	743.2"	748.2"	753.1"	758.0"	762.9"	767.8"
772.8"	777.7"										

END FEED LED NEON

Measurement does not include area required for routing power wire. Add 1.5" distance account for routing end feed power wire.

6.3"	11.2"	16.1"	21.0"	25.9"	30.9"	35.8"	40.7"	45.6"	50.5"	55.5"	60.4"
65.3"	70.2"	75.1"	80.1"	85.0"	89.9"	94.8"	99.7"	104.7"	109.6"	114.5"	119.4"
124.3"	129.3"	134.2"	139.1"	144.0"	148.9"	153.9"	158.8"	163.7"	168.6"	173.5"	178.5"
183.4"	188.3"	193.2"	198.1"	203.1"	208.0"	212.9"	217.8"	222.7"	227.7"	232.6"	237.5"
242.4"	247.3"	252.3"	257.2"	262.1"	267.0"	271.9"	276.9"	281.8"	286.7"	291.6"	296.5"
301.5"	306.4"	311.3"	316.2"	321.1"	326.1"	331.0"	335.9"	340.8"	345.7"	350.7"	355.6"
360.5"	365.4"	370.3"	375.3"	380.2"	385.1"	390.0"	394.9"	399.9"	404.8"	409.7"	414.6"
419.5"	424.5"	429.4"	434.3"	439.2"	444.1"	449.1"	454.0"	458.9"	463.8"	468.7"	473.7"
478.6"	483.5"	488.4"	493.3"	498.3"	503.2"	508.1"	513.0"	517.9"	522.9"	527.8"	532.7"
537.6"	542.5"	547.5"	552.4"	557.3"	562.2"	567.1"	572.1"	577.0"	581.9"	586.8"	591.7"
596.7"	601.6"	606.5"	611.4"	616.3"	621.3"	626.2"	631.1"	636.0"	640.9"	645.9"	650.8"
655.7"	660.6"	665.5"	670.5"	675.4"	680.3"	685.2"	690.1"	695.1"	700.0"	704.9"	709.8"
714.7"	719.7"	724.6"	729.5"	734.4"	739.3"	744.3"	749.2"	754.1"	759.0"	763.9"	768.9"
773.8"	778.7"										

LINE VOLTAGE STATIC RED/AMBER LED NEON - 120V

Square Profile / Top Bending / PVC

MOUNTING CHANNELS (CONTINUED ON NEXT PAGE)

NOTE: Leave a 0.5" to 1" gap between Neon power feed and mounting channel, to avoid undue stress on power feed cables.

ALUMINUM MOUNTING CHANNEL

Silver anodized finish

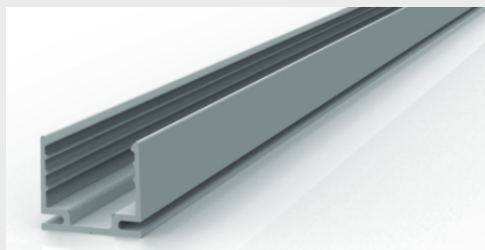

Mounting Clip

Recommended 2 clips every 12"

Part Number: LLI-NS-MCL-1.5IN

Dimensions: 1.5" L x 0.83" H x 0.74" W

20" Mounting Channel

Part Number: LLI-NS-EXT-20IN

Dimensions: 20" L x 0.71" H x 0.75" W

39" Mounting Channel

Part Number: LLI-NS-EXT-39IN

Dimensions: 39" L x 0.71" H x 0.75" W

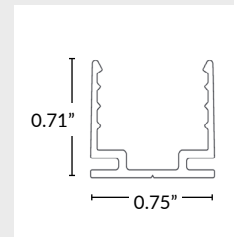

FLEXIBLE STAINLESS STEEL MOUNTING CHANNEL

Silver anodized finish



4" Mounting Channel

Part Number: LLI-NS-EXT-F-4IN

Dimensions: 4" L x 0.79" H x 0.69" W

12" Mounting Channel

Part Number: LLI-NS-EXT-F-12IN

Dimensions: 12" L x 0.79" H x 0.69" W

20" Mounting Channel

Part Number: LLI-NS-EXT-F-20IN

Dimensions: 20" L x 0.79" H x 0.69" W

35" Mounting Channel

Part Number: LLI-NS-EXT-F-35IN

Dimensions: 35" L x 0.79" H x 0.69" W

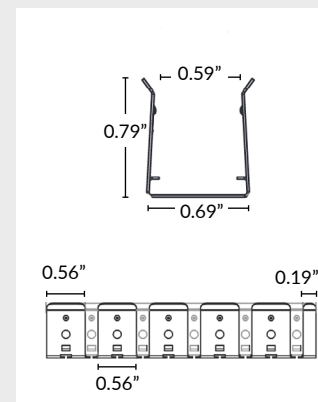

PLASTIC MOUNTING CHANNEL

Use in submersible applications only

White finish

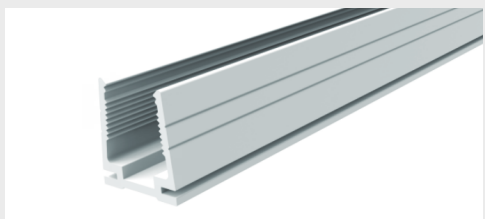

20" Mounting Channel

Part Number: LLI-NS-EXT-P-20IN

Dimensions: 20" L x 0.83" H x 0.74" W

39" Mounting Channel

Part Number: LLI-NS-EXT-P-39IN

Dimensions: 39.4" L x 0.83" H x 0.74" W

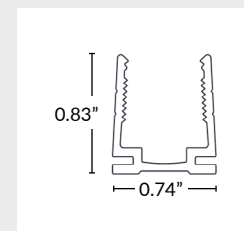

SILICONE GRIP ALUMINUM MOUNTING CHANNEL

Recommended for ceiling and wall applications

Silver anodized finish

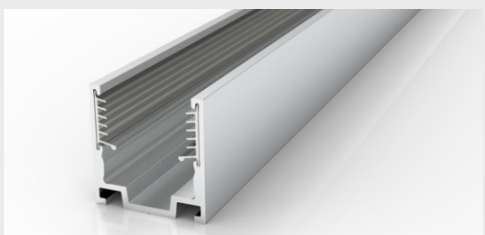

Mounting Clip

Recommended 2 clips every 12"

Part Number: LLI-NS-MCL-SG-1.5IN

Dimensions: 1.5" L x 0.83" H x 0.74" W

20" Mounting Channel

Part Number: LLI-NS-EXT-SG-20IN

Dimensions: 20" L x 0.82" H x 0.8" W

39" Mounting Channel

Part Number: LLI-NS-EXT-SG-39IN

Dimensions: 39.4" L x 0.82" H x 0.8" W

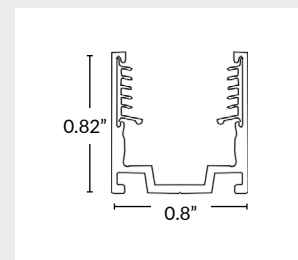

LINE VOLTAGE STATIC RED/AMBER LED NEON - 120V

Square Profile / Top Bending / PVC

MOUNTING CHANNELS (CONTINUED)

NOTE: Leave a 0.5" to 1" gap between Neon power feed and mounting channel, to avoid undue stress on power feed cables.

ALUMINUM RACEWAY CHANNEL WITH SILICONE GRIP

Silver anodized finish

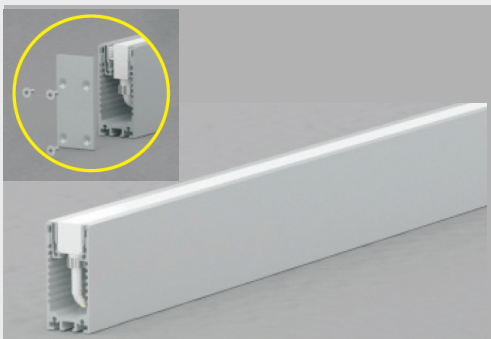

Two (2) endcaps and screws included.

20" Mounting Channel

Part Number: LLI-NS-RCW-SG-20IN
Dimensions: 20" L x 2.44" H x 1.14" W

39" Mounting Channel

Part Number: LLI-NS-RCW-SG-39IN
Dimensions: 39.4" L x 2.44" H x 1.14" W

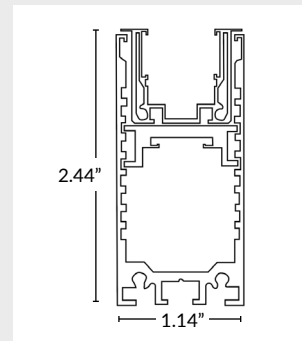

RECESSED MOUNTING CHANNEL

Silver anodized finish

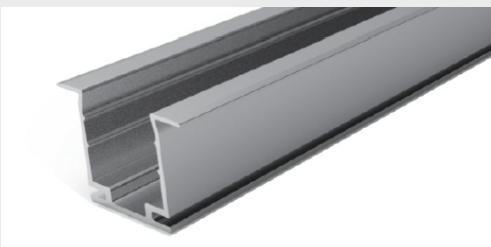

Mounting Clip

Recommended 2 clips every 12"

Part Number: LLI-NS-MCL-R-1.5IN
Dimensions: 1.5" L x 0.83" H x 1.1" W

20" Mounting Channel

Part Number: LLI-NS-EXT-R-20IN
Dimensions: 20" L x 0.83" H x 1.1" W

39" Mounting Channel

Part Number: LLI-NS-EXT-R-39IN
Dimensions: 39.4" L x 0.83" H x 1.1" W

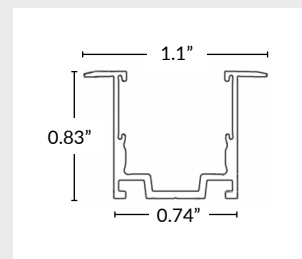

SILICONE GRIP RECESSED CHANNEL

Recommended for ceiling and wall applications

Silver anodized finish



Mounting Clip

Recommended 2 clips every 12"

Part Number: LLI-NS-MCL-RSG-0.8IN
Dimensions: 0.8" L x 0.82" H x 1.18" W

20" Mounting Channel

Part Number: LLI-NS-EXT-RSG-20IN
Dimensions: 20" L x 0.82" H x 1.18" W

39" Mounting Channel

Part Number: LLI-NS-EXT-RSG-39IN
Dimensions: 39.4" L x 0.82" H x 1.18" W

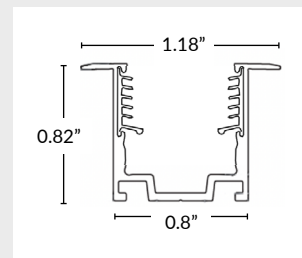

ADJUSTABLE MOUNTING BRACKET

Recommended 3 brackets for every 39" channel

Adjusts in 15° increments, notches every 30°



Part Number: LLI-NS-MCL-ADJ
Dimensions: 1" L x 1.6" H x 1.8" W

