

STATIC WHITE LED NEON - 24V

Square Profile / Side Bending / PVC / IP68

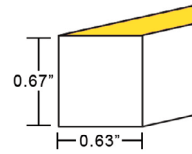
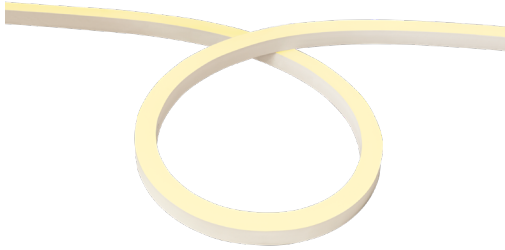

TECHNICAL INFORMATION

NOTE: All data has +/- 5% tolerance.

WATTAGE	3.7W per foot
IP RATING	IP68 - wet locations. Protected against temporary submersion, limited protection against harsh environments.
PROFILE	Square
BEND ORIENTATION	Side Bending
HOUSING MATERIAL	PVC
OUTPUT	2200K - 115 lm/ft 2700K - 121 lm/ft 3000K - 128 lm/ft 3500K - 134 lm/ft 4000K - 143 lm/ft 5700K - 150 lm/ft
CRI	80+
INPUT VOLTAGE	24VDC
SEGMENT LENGTH	Every 2.2", not field-cuttable
MAXIMUM RUN	32 feet
DIMENSIONS	0.63" W x 0.67" H (16mm x 17mm)
MINIMUM BEND	11.8" diameter
INSTALLATION TEMP.	32°F to 140°F (do not install when temperatures are below freezing)
OPERATING TEMP.	-13°F to 140°F
WARRANTY	3 year limited
POWER SUPPLY	Compatible with 24VDC power supplies - see power supply section of website.

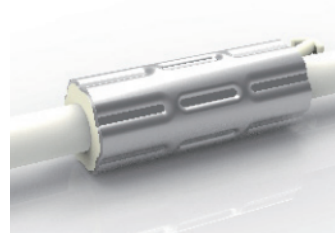

ANTI-WICKING FERRULE

Standard on all LED Neon power cables. Located 4.5" from the connector. Protects against water ingress and circuit board corrosion.
H 0.47" x W 1.18"

MOUNTING OPTIONS (SOLD SEPARATELY)

More clips and channel options available (see page 6-7).

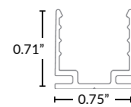

Mounting Clip

Part Number: LLI-NS-MCL-1.5IN
1.38" L x 0.71" H x 0.75" W

Recommended: 2 mounting clips for every 12in of Neon.

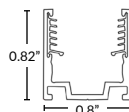

Silicone Grip Mounting Clip

Part Number: LLI-NS-MCL-SG-0.8IN
0.8" L x 0.82" H x 0.8" W

Recommended: 2 mounting clips for every 12in of Neon.

NOTE: Neon sections may be mounted end-to-end on the non-power feed end to create the appearance of longer runs. End-to-end Neon sections must have a 0.5" to 1" gap to allow for expansion/contraction. A dark spot may be visible at <20ft viewing distance.

PART NUMBER BUILDER / ORDERING GUIDE

Example part number: LLI-N3.7W-68-SSP-22K-24V-96in

SERIES	IP RATING	TYPE	CCT	VOLTAGE	LENGTH
LLI-N3.7W	68	SSP		24V	
			22K - 115 lm/ft		(enter length in inches, up to 384")
			27K - 121 lm/ft		
			30K - 128 lm/ft		
			35K - 134 lm/ft		
			40K - 143 lm/ft		
			57K - 150 lm/ft		

STATIC WHITE LED NEON - 24V

Square Profile / Side Bending / PVC / IP68

ORIENTATION & MINIMUM BEND DIAMETER

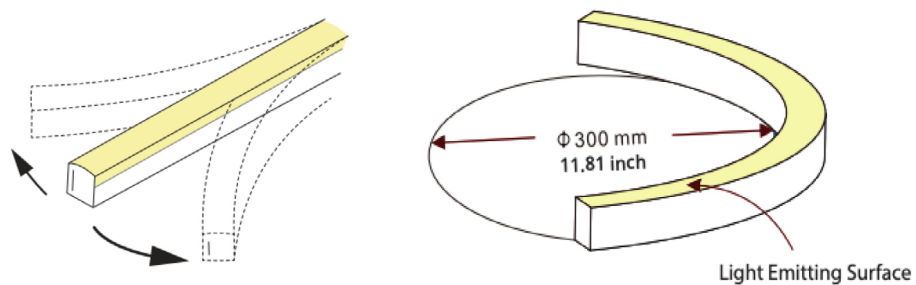

POWER FEED ORIENTATION GUIDE

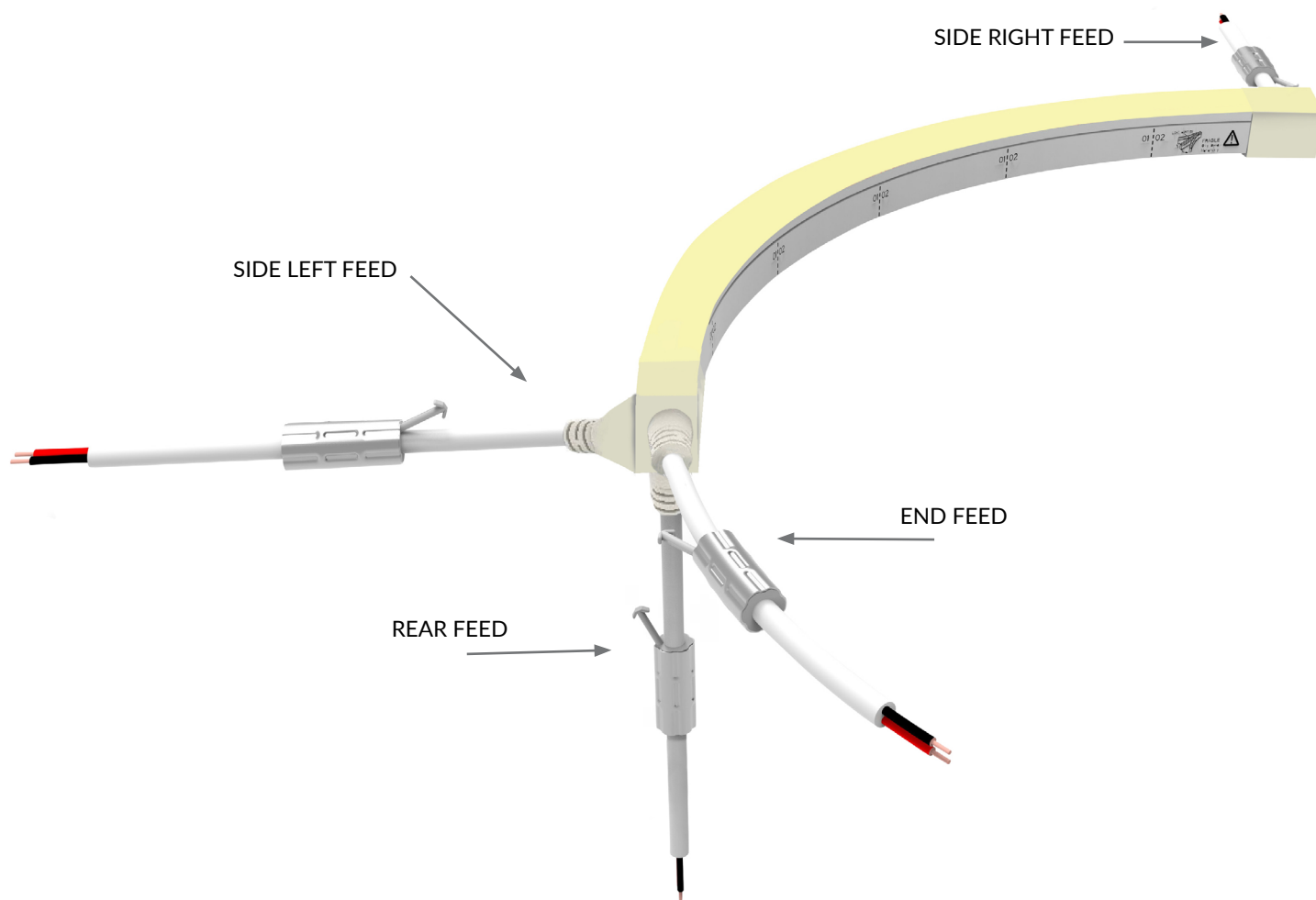

STATIC WHITE LED NEON - 24V

Square Profile / Side Bending / PVC / IP68

POWER FEED & TERMINATION OPTIONS (IP68)

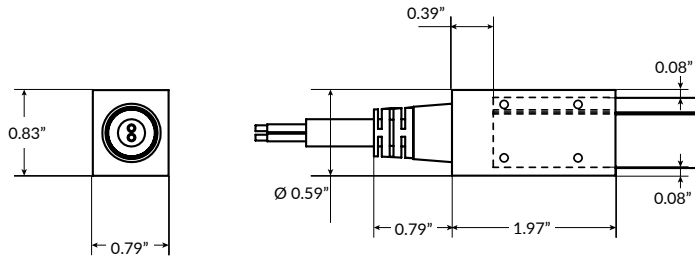
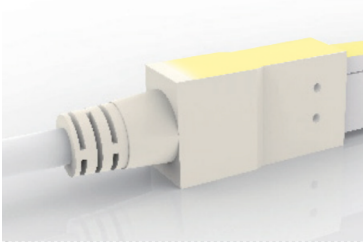

End Power Feed

SERIES	LENGTH
LLI-NS-68-PWR2-EF	39IN 118IN 196IN 393IN

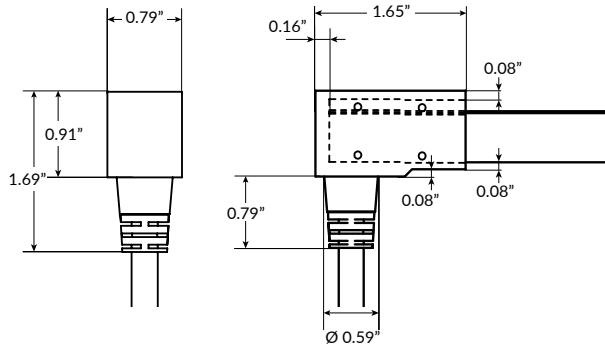
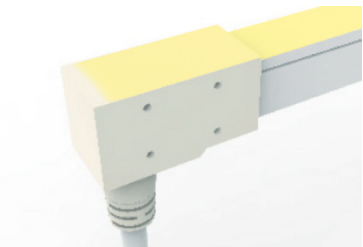

Rear Power Feed

SERIES	LENGTH
LLI-NS-68-PWR2-RF	39IN 118IN 196IN 393IN

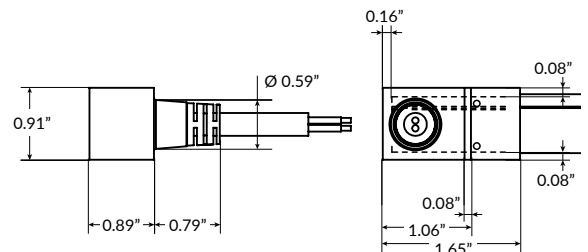
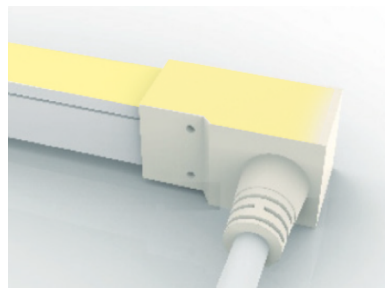
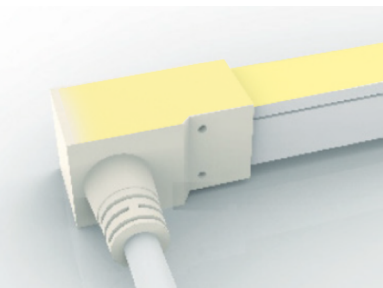

Side Left Power Feed

SERIES	SIDE	LENGTH
LLI-NS-68-PWR2	SL	39IN 118IN 196IN 393IN

Side Right Power Feed

SERIES	SIDE	LENGTH
LLI-NS-68-PWR2	SR	39IN 118IN 196IN 393IN

STATIC WHITE LED NEON - 24V

Square Profile / Side Bending / PVC / IP68

POWER FEED & TERMINATION OPTIONS (IP68)

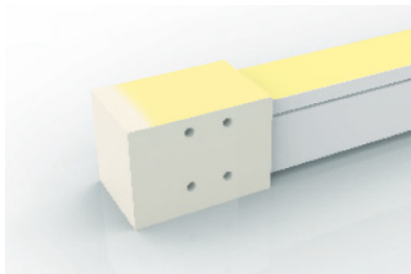

End Cap

SERIES

LLI-NS-68-EC

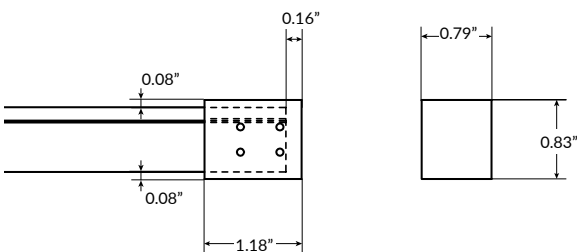

Jumper Power Connector (maximum 4 per run)

SERIES

LLI-NS-68-CON2

SIDE LENGTH (L)

SR	12IN
SL	39IN
EF	118IN
RF	196IN
	393IN

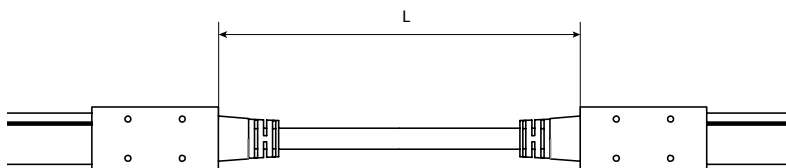

STATIC WHITE LED NEON - 24V

Square Profile / Side Bending / PVC / IP68

OVERALL LENGTH / CUT POINT GUIDE

Dimension tolerance of $\pm 1/8"$.

This product expands and contracts in varying ambient temperatures. If butting Neon end-to-end, add 1/2" to 1" gap between sections for expansion.

SIDE FEED AND REAR FEED LED NEON

2.5"	4.7"	6.9"	9.1"	11.3"	13.5"	15.6"	17.8"	20.0"	22.2"	24.4"	26.6"
28.8"	31.0"	33.2"	35.4"	37.5"	39.7"	41.9"	44.1"	46.3"	48.5"	50.7"	52.9"
55.1"	57.3"	59.4"	61.6"	63.8"	66.0"	68.2"	70.4"	72.6"	74.8"	77.0"	79.2"
81.3"	83.5"	85.7"	87.9"	90.1"	92.3"	94.5"	96.7"	98.9"	101.1"	103.2"	105.4"
107.6"	109.8"	112.0"	114.2"	116.4"	118.6"	120.8"	123.0"	125.1"	127.3"	129.5"	131.7"
133.9"	136.1"	138.3"	140.5"	142.7"	144.9"	147.0"	149.2"	151.4"	153.6"	155.8"	158.0"
160.2"	162.4"	164.6"	166.8"	168.9"	171.1"	173.3"	175.5"	177.7"	179.9"	182.1"	184.3"
186.5"	188.7"	190.8"	193.0"	195.2"	197.4"	199.6"	201.8"	204.0"	206.2"	208.4"	210.6"
212.7"	214.9"	217.1"	219.3"	221.5"	223.7"	225.9"	228.1"	230.3"	232.5"	234.6"	236.8"
239.0"	241.2"	243.4"	245.6"	247.8"	250.0"	252.2"	254.4"	256.5"	258.7"	260.9"	263.1"
265.3"	267.5"	269.7"	271.9"	274.1"	276.3"	278.4"	280.6"	282.8"	285.0"	287.2"	289.4"
291.6"	293.8"	296.0"	298.2"	300.3"	302.5"	304.7"	306.9"	309.1"	311.3"	313.5"	315.7"
317.9"	320.1"	322.2"	324.4"	326.6"	328.8"	331.0"	333.2"	335.4"	337.6"	339.8"	342.0"
344.1"	346.3"	348.5"	350.7"	352.9"	355.1"	357.3"	359.5"	361.7"	363.9"	366.0"	368.2"
370.4"	372.6"	374.8"	377.0"	379.2"	381.4"	383.6"					

END FEED LED NEON

Measurement does not include area required for routing power wire. Add 1.5" distance account for routing end feed power wire.

3.5"	5.7"	7.9"	10.1"	12.3"	14.5"	16.7"	18.9"	21.0"	23.2"	25.4"	27.6"
29.8"	32.0"	34.2"	36.4"	38.6"	40.8"	42.9"	45.1"	47.3"	49.5"	51.7"	53.9"
56.1"	58.3"	60.5"	62.7"	64.8"	67.0"	69.2"	71.4"	73.6"	75.8"	78.0"	80.2"
82.4"	84.6"	86.7"	88.9"	91.1"	93.3"	95.5"	97.7"	99.9"	102.1"	104.3"	106.5"
108.6"	110.8"	113.0"	115.2"	117.4"	119.6"	121.8"	124.0"	126.2"	128.4"	130.5"	132.7"
134.9"	137.1"	139.3"	141.5"	143.7"	145.9"	148.1"	150.3"	152.4"	154.6"	156.8"	159.0"
161.2"	163.4"	165.6"	167.8"	170.0"	172.2"	174.3"	176.5"	178.7"	180.9"	183.1"	185.3"
187.5"	189.7"	191.9"	194.1"	196.2"	198.4"	200.6"	202.8"	205.0"	207.2"	209.4"	211.6"
213.8"	216.0"	218.1"	220.3"	222.5"	224.7"	226.9"	229.1"	231.3"	233.5"	235.7"	237.9"
240.0"	242.2"	244.4"	246.6"	248.8"	251.0"	253.2"	255.4"	257.6"	259.8"	261.9"	264.1"
266.3"	268.5"	270.7"	272.9"	275.1"	277.3"	279.5"	281.7"	283.8"	286.0"	288.2"	290.4"
292.6"	294.8"	297.0"	299.2"	301.4"	303.6"	305.7"	307.9"	310.1"	312.3"	314.5"	316.7"
318.9"	321.1"	323.3"	325.5"	327.6"	329.8"	332.0"	334.2"	336.4"	338.6"	340.8"	343.0"
345.2"	347.4"	349.5"	351.7"	353.9"	356.1"	358.3"	360.5"	362.7"	364.9"	367.1"	369.3"
371.4"	373.6"	375.8"	378.0"	380.2"	382.4"	384.6"					

STATIC WHITE LED NEON - 24V

Square Profile / Side Bending / PVC / IP68

MOUNTING CHANNELS

NOTE: Leave a 0.5" to 1" gap between Neon power feed and mounting channel, to avoid undue stress on power feed cables.

ALUMINUM MOUNTING CHANNEL

Silver anodized finish

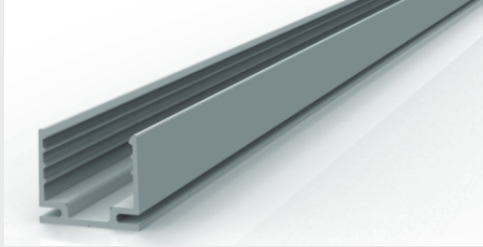

Mounting Clip

Recommended 2 clips every 12"

Part Number: LLI-NS-MCL-1.5IN

Dimensions: 1.5" L x 0.83" H x 0.74" W

20" Mounting Channel

Part Number: LLI-NS-EXT-20IN

Dimensions: 20" L x 0.71" H x 0.75" W

39" Mounting Channel

Part Number: LLI-NS-EXT-39IN

Dimensions: 39" L x 0.71" H x 0.75" W

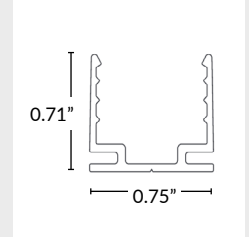

FLEXIBLE STAINLESS STEEL MOUNTING CHANNEL

Silver anodized finish



4" Mounting Channel

Part Number: LLI-NS-EXT-F-4IN

Dimensions: 4" L x 0.79" H x 0.69" W

12" Mounting Channel

Part Number: LLI-NS-EXT-F-12IN

Dimensions: 12" L x 0.79" H x 0.69" W

20" Mounting Channel

Part Number: LLI-NS-EXT-F-20IN

Dimensions: 20" L x 0.79" H x 0.69" W

35" Mounting Channel

Part Number: LLI-NS-EXT-F-35IN

Dimensions: 35" L x 0.79" H x 0.69" W

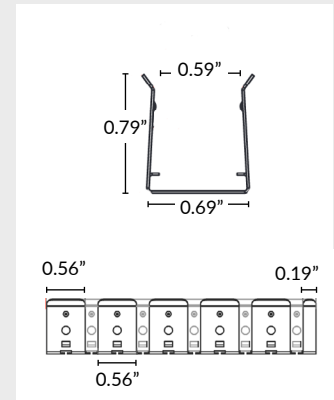

PLASTIC MOUNTING CHANNEL

Use in submersible applications only

White finish

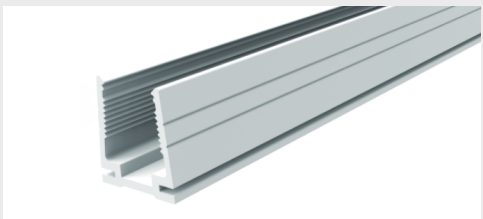

20" Mounting Channel

Part Number: LLI-NS-EXT-P-20IN

Dimensions: 20" L x 0.83" H x 0.74" W

39" Mounting Channel

Part Number: LLI-NS-EXT-P-39IN

Dimensions: 39.4" L x 0.83" H x 0.74" W

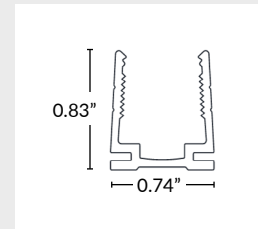

SILICONE GRIP ALUMINUM MOUNTING CHANNEL

Recommended for ceiling and wall applications

Silver anodized finish



Mounting Clip

Recommended 2 clips every 12"

Part Number: LLI-NS-MCL-SG-0.8IN

Dimensions: 0.8" L x 0.83" H x 0.74" W

20" Mounting Channel

Part Number: LLI-NS-EXT-SG-20IN

Dimensions: 20" L x 0.82" H x 0.8" W

39" Mounting Channel

Part Number: LLI-NS-EXT-SG-39IN

Dimensions: 39.4" L x 0.82" H x 0.8" W

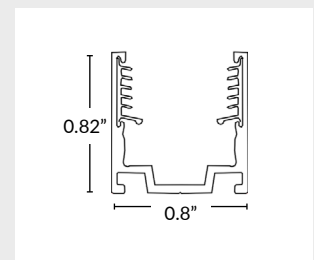

STATIC WHITE LED NEON - 24V

Square Profile / Side Bending / PVC / IP68

MOUNTING CHANNELS (CONTINUED)

NOTE: Leave a 0.5" to 1" gap between Neon power feed and mounting channel, to avoid undue stress on power feed cables.

ALUMINUM RACEWAY CHANNEL WITH SILICONE GRIP

Silver anodized finish

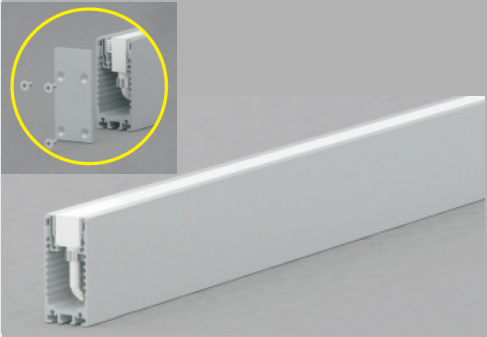

Two (2) endcaps and screws included.

20" Mounting Channel

Part Number: LLI-NS-RCW-SG-20IN
Dimensions: 20" L x 2.44" H x 1.14" W

39" Mounting Channel

Part Number: LLI-NS-RCW-SG-39IN
Dimensions: 39.4" L x 2.44" H x 1.14" W

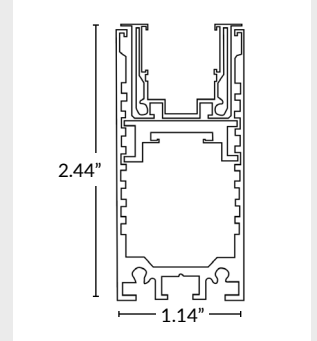

RECESSED MOUNTING CHANNEL

Silver anodized finish

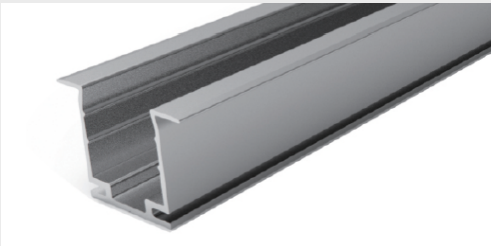

Mounting Clip

Recommended 2 clips every 12"

Part Number: LLI-NS-MCL-R-1.5IN
Dimensions: 1.5" L x 0.83" H x 1.1" W

20" Mounting Channel

Part Number: LLI-NS-EXT-R-20IN
Dimensions: 20" L x 0.83" H x 1.1" W

39" Mounting Channel

Part Number: LLI-NS-EXT-R-39IN
Dimensions: 39.4" L x 0.83" H x 1.1" W

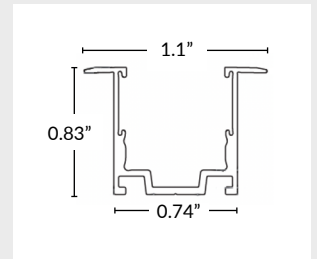

SILICONE GRIP RECESSED CHANNEL

Recommended for ceiling and wall applications
Silver anodized finish



Mounting Clip

Recommended 2 clips every 12"

Part Number: LLI-NS-MCL-RSG-0.8IN
Dimensions: 0.8" L x 0.82" H x 1.18" W

20" Mounting Channel

Part Number: LLI-NS-EXT-RSG-20IN
Dimensions: 20" L x 0.82" H x 1.18" W

39" Mounting Channel

Part Number: LLI-NS-EXT-RSG-39IN
Dimensions: 39.4" L x 0.82" H x 1.18" W

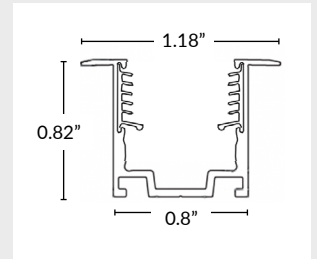

ADJUSTABLE MOUNTING BRACKET

Recommended 3 brackets for every 39" channel
Adjusts in 15° increments, notches every 30°



Part Number: LLI-NS-BKT-ADJ
Dimensions: 1" L x 1.6" H x 1.8" W

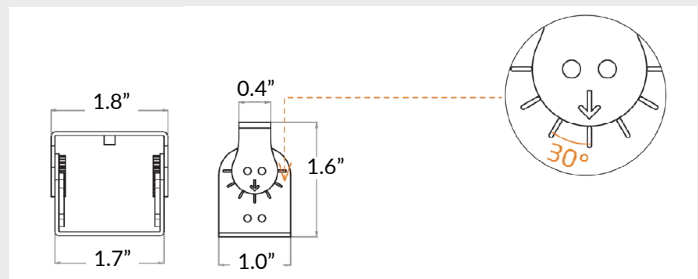

POWER SUPPLIES SOLD SEPARATELY

DIMMABLE ELECTRONIC 0-10V

Optimal performance dims to 0%.*



PART NUMBER	CAPACITY	INPUT	OUTPUT	CLASS	LOCATION	L	W	H
LLI-PS-DE010-030W-24V-KO	30W	120/277V	24V	CLASS 2	IP66 WET	6.5"	3.6"	1.6"
LLI-PS-DE010-060W-24V-KO	60W	120/277V	24V	CLASS 2	IP66 WET	7.4"	3.6"	1.6"
LLI-PS-DE010-096W-24V-KO	96W	120/277V	24V	CLASS 2	IP66 WET	8.7"	3.7"	1.7"
LLI-PS-DE010-200W-24V-KO	200W	120/277V	24V	CLASS 1	IP66 WET	10.2"	4.1"	1.8"
LLI-PS-DE010-300W-24V-KO	300W	120/277V	24V	CLASS 1	IP66 WET	10.9"	4.3"	1.8"

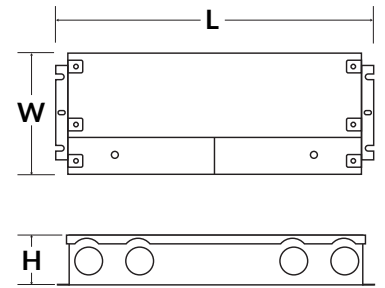

NON-DIMMABLE ELECTRONIC



PART NUMBER	CAPACITY	INPUT	OUTPUT	CLASS	LOCATION	L	W	H
LLI-PS-NDE-030W-24V-KO	30W	100-277V	24V	CLASS 2	IP66 WET	6.5"	3.5"	1.02"
LLI-PS-NDE-060W-24V-KO	60W	100-277V	24V	CLASS 2	IP66 WET	7.4"	3.5"	1.2"
LLI-PS-NDE-096W-24V-KO	96W	100-277V	24V	CLASS 2	IP66 WET	8.7"	3.7"	1.7"
LLI-PS-NDE-200W-24V-KO	200W	100-277V	24V	CLASS 1	IP66 WET	10.3"	4.1"	1.8"
LLI-PS-NDE-300W-24V-KO	300W	100-277V	24V	CLASS 1	IP66 WET	10.9"	4.3"	1.8"

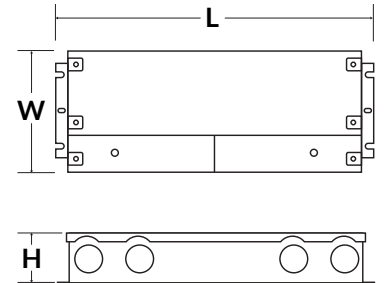

DIMMABLE ELECTRONIC FLICKER-FREE

Optimal performance dims to 2-5%.



PART NUMBER	CAPACITY	INPUT	OUTPUT	CLASS	LOCATION	L	W	H
LLI-PS-UDEFF-030W-24V-KO	30W	110-277V	24V	CLASS 2	IP66 WET	6.5"	3.6"	1.0"
LLI-PS-UDEFF-060W-24V-KO	60W	110-277V	24V	CLASS 2	IP66 WET	7.4"	3.6"	1.0"
LLI-PS-UDEFF-096W-24V-KO	96W	110-277V	24V	CLASS 2	IP66 WET	8.7"	3.7"	1.6"
LLI-PS-UDEFF-200W-24V-KO	200W	110-277V	24V	CLASS 1	IP66 WET	10.2"	4.1"	1.8"
LLI-PS-UDEFF-300W-24V-KO	300W	110-277V	24V	CLASS 1	IP66 WET	11.0"	4.3"	1.8"

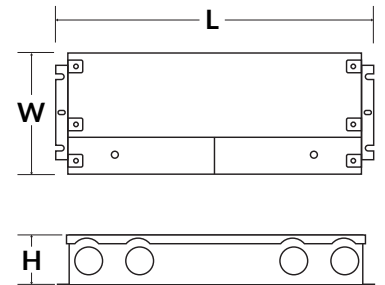

DIMMABLE MAGNETIC

Optimal performance dims to 5-10%.*



PART NUMBER	CAPACITY	INPUT	OUTPUT	CLASS	LOCATION	L	W	H
LLI-PS-DM-020W-24V-KO	20W	120/277V	24V	CLASS 2	NEMA 3R WET	7.38"	2.11"	1.60"
LLI-PS-DM-040W-24V-KO	40W	120/277V	24V	CLASS 2	NEMA 3R WET	7.38"	2.11"	1.60"
LLI-PS-DM-060W-24V-KO	60W	120/277V	24V	CLASS 2	NEMA 3R WET	8.13"	3.93"	1.59"
LLI-PS-DM-100W-24V-KO	100W	120/277V	24V	CLASS 2	NEMA 3R WET	8.13"	3.93"	1.59"
LLI-PS-DM-150W-24V-KO	150W	120/277V	24V	CLASS 1	NEMA 3R WET	8.79"	4.15"	3.41"
LLI-PS-DM-200W-24V-KO	200W	120/277V	24V	CLASS 1	NEMA 3R WET	8.79"	4.15"	3.41"
LLI-PS-DM-300W-24V-KO	300W	120/277V	24V	CLASS 1	NEMA 3R WET	8.79"	4.15"	3.41"
LLI-PS-DM-300W-24V-CL2-KO	6 x 50W	120/277V	24V	CLASS 2	NEMA 3R WET	10.29"	5.69"	3.43"
LLI-PS-DM-600W-24V-KO	2 x 300W	120/277V	24V	CLASS 1	NEMA 3R WET	10.29"	6.79"	4.68"

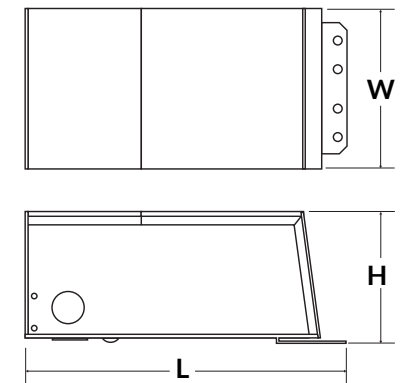

LUTRON HI-LUME PREMIER 0.1% DIMMABLE ELECTRONIC

Soft-on, Fade-to-Black, continuous flicker-free dimming from 100% to 0.1.



PART NUMBER	CAPACITY	INPUT	OUTPUT	CLASS	LOCATION	L	W	H
L3D0-96W24V-U	96W	120-277V	24V	CLASS 2	IP20 DRY	10.5"	5.5"	2.0"

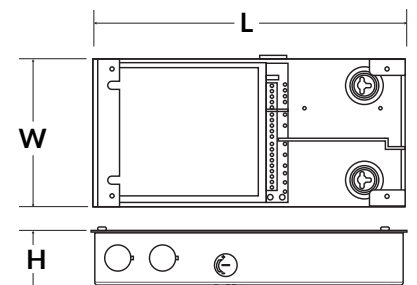

*Performance can be affected by driver loading and dimmer type.