

# TUNABLE WHITE LED NEON - 24V

Mini Square Profile / Top Bending / Silicone (ST49)

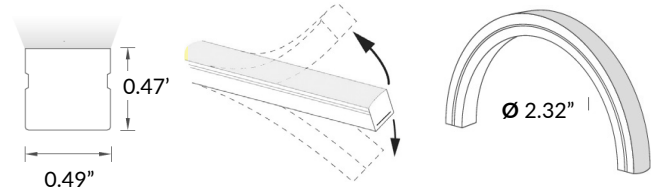
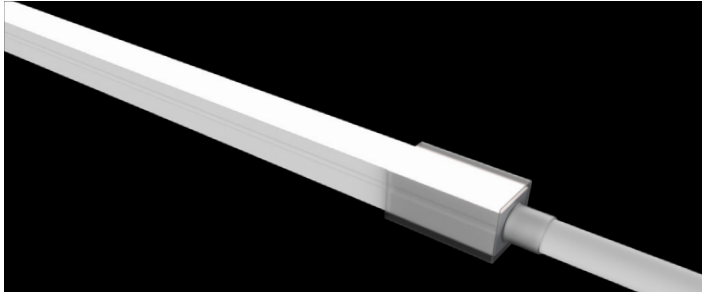

## TECHNICAL INFORMATION

NOTE: All data has +/- 5% tolerance.

WATTAGE	4.4W per foot
IP RATING	IP67 - wet locations. Protected against temporary submersion, limited protection against harsh environments.
IK RATING	IK08
BEAM ANGLE	113°
HOUSING MATERIAL	Silicone, UV resistant per ISO 4892-3
OUTPUT	1800K - 3500K adjustable - 264 lm/ft 2700K - 5200K adjustable - 278 lm/ft
CRI	80+
INPUT VOLTAGE	24VDC
SEGMENT LENGTH	Every 1.97", not field-cuttable
MAXIMUM RUN	32 feet
DIMENSIONS	0.49" W x 0.47" H
MINIMUM BEND	2.32" diameter
INSTALLATION TEMP.	32°F to 140°F (do not install when temperatures are below freezing)
OPERATING TEMP.	-4°F to 140°F
WARRANTY	3 year limited
POWER SUPPLY	Compatible with all non-dim 24VDC power supplies
CONTROLS	Color and intensity can be adjusted with DMX decoder or RF receiver and controller

### FEED TYPES

Product has 48in hard wire end feed unless otherwise specified. Other options subject to availability - contact us. Power Feed Caps and End Caps illuminate continuously to the end.

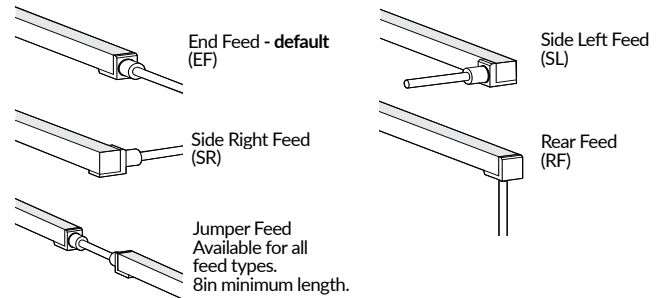

### MOUNTING

See page 3 for details. 2 clips recommended per 12in of LED Neon. Sold separately.

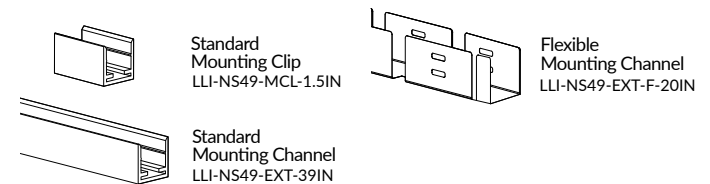

## ORDERING GUIDE

SERIES	IP RATING	TYPE	COLOR	VOLTAGE	LENGTH
LLI-N4.4W	67	ST49		24V	
			1835 - 164 lm/ft 2752 - 278 lm/ft		Enter total length in inches. Nominal length only. Actual lengths vary by cut point. Refer to page 3.

Example part number: LLI-N4.4W-67-ST49-2K5-24V-96in

Default 48in end feed power wire (PWR48EF) included. Use OPTIONAL section to specify other power feed(s).

### ← PRODUCT CODE

### OPTIONAL CODE →

POWER FEED		
LEAD TYPE	LEAD LENGTH	FEED TYPE

Default [blank] - 48" hard wire end feed (PWR48EF)

**PWR** Hard Wire (no connector) Enter desired wire length in inches  
**EF** End Feed  
**RF** Rear Feed  
**SL** Side Left  
**SR** Side Right

For runs that require power feeds on both ends, repeat optional power feed code.

# TUNABLE WHITE LED NEON - 24V

Mini Square Profile / Top Bending / Silicone (ST49)

## OVERALL LENGTH / SEGMENT GUIDE

Dimension tolerance of  $\pm 1/8"$ .

Measurements below do not include area required for routing power wire. Add 1" distance to layout to account for routing end feed power wire.

This product expands and contracts in varying ambient temperatures. If butting Neon end-to-end, add 1/2" to 1" gap between sections for expansion.

8.3"	10.3"	12.3"	14.3"	16.2"	18.2"	20.2"	22.1"	24.1"	26.1"	28.0"	30.0"
32.0"	33.9"	35.9"	37.9"	39.8"	41.8"	43.8"	45.7"	47.7"	49.7"	51.7"	53.6"
55.6"	57.6"	59.5"	61.5"	63.5"	65.4"	67.4"	69.4"	71.3"	73.3"	75.3"	77.2"
79.2"	81.2"	83.1"	85.1"	87.1"	89.1"	91.0"	93.0"	95.0"	96.9"	98.9"	100.9"
102.8"	104.8"	106.8"	108.7"	110.7"	112.7"	114.6"	116.6"	118.6"	120.6"	122.5"	124.5"
126.5"	128.4"	130.4"	132.4"	134.3"	136.3"	138.3"	140.2"	142.2"	144.2"	146.1"	148.1"
150.1"	152.0"	154.0"	156.0"	158.0"	159.9"	161.9"	163.9"	165.8"	167.8"	169.8"	171.7"
173.7"	175.7"	177.6"	179.6"	181.6"	183.5"	185.5"	187.5"	189.4"	191.4"	193.4"	195.4"
197.3"	199.3"	201.3"	203.2"	205.2"	207.2"	209.1"	211.1"	213.1"	215.0"	217.0"	219.0"
220.9"	222.9"	224.9"	226.9"	228.8"	230.8"	232.8"	234.7"	236.7"	238.7"	240.6"	242.6"
244.6"	246.5"	248.5"	250.5"	252.4"	254.4"	256.4"	258.3"	260.3"	262.3"	264.3"	266.2"
268.2"	270.2"	272.1"	274.1"	276.1"	278.0"	280.0"	282.0"	283.9"	285.9"	287.9"	289.8"
291.8"	293.8"	295.7"	297.7"	299.7"	301.7"	303.6"	305.6"	307.6"	309.5"	311.5"	313.5"
315.4"	317.4"	319.4"	321.3"	323.3"	325.3"	327.2"	329.2"	331.2"	333.1"	335.1"	337.1"
339.1"	341.0"	343.0"	345.0"	346.9"	348.9"	350.9"	352.8"	354.8"	356.8"	358.7"	360.7"
362.7"	364.6"	366.6"	368.6"	370.6"	372.5"	374.5"	376.5"	378.4"	380.4"	382.4"	384.3"
386.3"	388.3"	390.2"	392.2"								

# TUNABLE WHITE LED NEON - 24V

Mini Square Profile / Top Bending / Silicone (ST49)

## ANTI-WICKING FERRULE

---

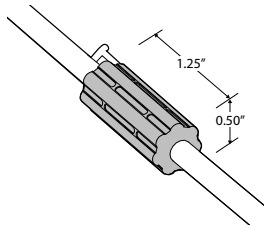

Standard on all LED Neon power feeds. Located 4-6" from the connector. Protects against water ingress and circuit board corrosion.

## MOUNTING CHANNELS AND CLIPS (SOLD SEPARATELY)

---

**NOTE:** Leave a 0.5" to 1" gap between Neon power feed and mounting channel, to avoid undue stress on power feed cables.

### ALUMINUM MOUNTING CHANNEL - SILVER ANODIZED

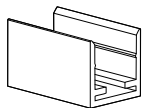

**Mounting Clip**  
Recommended 2 clips every 12"  
Part Number: LLI-NS49-MCL-1.5IN  
Dimensions: 1.5" L x 0.58" H x 0.59" W

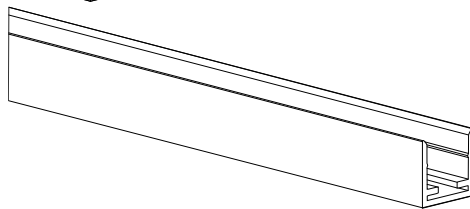

**39" Mounting Channel**  
Part Number: LLI-NS49-EXT-39IN  
Dimensions: 39" L x 0.58" H x 0.59" W

### FLEXIBLE ALUMINUM MOUNTING CHANNEL - WHITE POWDER COAT

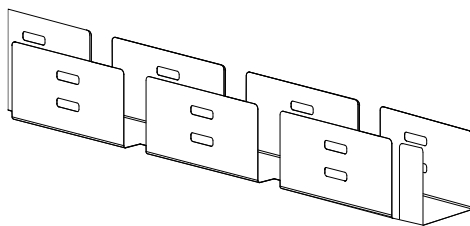

**20" Mounting Channel**  
Part Number: LLI-NS49-EXT-F-20IN  
Dimensions: 20" L x 0.53" H x 0.54" W

# TUNABLE WHITE LED NEON - 24V

Mini Square Profile / Top Bending / Silicone (ST49)

POWER SUPPLY (SOLD SEPARATELY)

NON-DIMMABLE ELECTRONIC 

PART NUMBER	CAPACITY	INPUT	OUTPUT	CLASS	LOCATION	L	W	H
LLI-PS-NDE-030W-24V-KO	30W	100-277V	24V	CLASS 2	IP66 WET	6.5"	3.5"	1.02"
LLI-PS-NDE-060W-24V-KO	60W	100-277V	24V	CLASS 2	IP66 WET	7.4"	3.5"	1.2"
LLI-PS-NDE-096W-24V-KO	96W	100-277V	24V	CLASS 2	IP66 WET	8.7"	3.7"	1.7"
LLI-PS-NDE-200W-24V-KO	200W	100-277V	24V	CLASS 1	IP66 WET	10.3"	4.1"	1.8"
LLI-PS-NDE-300W-24V-KO	300W	100-277V	24V	CLASS 1	IP66 WET	10.9"	4.3"	1.8"

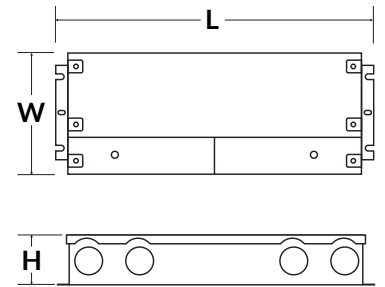

RF RECEIVER (SOLD SEPARATELY)

## LLI-C-RCV-UR-RF-4CH

CONTROLLER COMPATIBILITY	Compatible with all RF LLI-C-CTRL controllers.
LED COMPATIBILITY	Static Color, Tunable White & RGB(W) LEDs
CHANNELS	4 Channel, 8 Amp
INPUT VOLTAGE	12V / 24V (power supply not included)
CAPACITY	12V - 96W, 24V - 192W
FEATURES	Can be controlled by up to (8) controllers Can be synchronized with unlimited receivers up to 320ft away

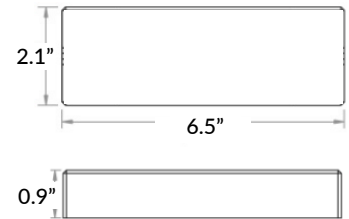

# TUNABLE WHITE LED NEON - 24V

Mini Square Profile / Top Bending / Silicone (ST49)

RF CONTROLLERS (SOLD SEPARATELY)

## REMOTE CONTROLLER

**LLI-C-CTRL-TW-HH**

RECEIVER COMPATIBILITY	Compatible with Universal RF receivers
LED COMPATIBILITY	Tunable White LEDs
INPUT VOLTAGE	Battery operated (3 AAA batteries not included)
FEATURES	Programmable up to 4 zones, 3 scenes Color adjustment Light intensity adjustment

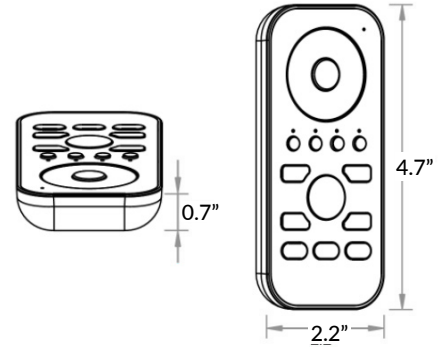

## TOUCH PANEL WALL CONTROLLER

**LLI-C-CTRL-TW-TP-WH**

RECEIVER COMPATIBILITY	Compatible with Universal RF receivers
LED COMPATIBILITY	Tunable White LEDs
INPUT VOLTAGE	12V DC power supply required (not included)
FEATURES	Control range $\geq$ 65ft Programmable up to 3 scenes 4 color presets Color adjustment Light intensity adjustment

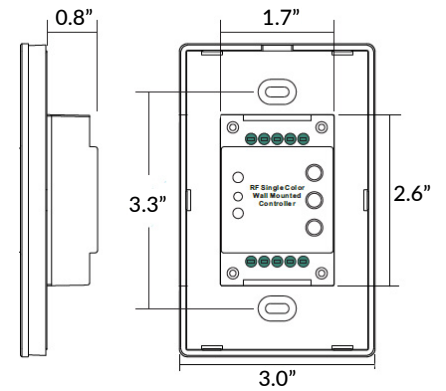

# TUNABLE WHITE LED NEON - 24V

Mini Square Profile / Top Bending / Silicone (ST49)

DMX DECODERS (SOLD SEPARATELY)

## DMX512 DECODER

### LLI-C-DEC-DMX512-8A

LOCATION RATING	Indoor only
FUNCTION	Static color, variable white, RGB(W) LEDs
CHANNELS	4 channel output, 8 Amp maximum 512 addressable DMX channels
CAPACITY	12V - 96W maximum
	24V - 192W maximum
COMPATIBILITY	Compatible with LLI-C-CTRL-DMX controllers

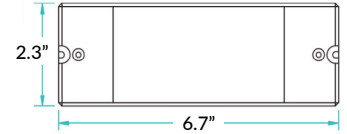

### POWER

Power supply not included. 12V/24V non-dimming power supply required.

## RDM DMX512 DECODER

### LLI-C-DEC-DMX512-8A-RDM

OUTPUT	8A maximum, 4 channels
LOCATION RATING	Indoor only
FUNCTION	RDM communication and PWM dimming for static white, static color, tunable white, and RGB(W) LEDs
CHANNELS	4 channel output, 8 Amp maximum 512 addressable DMX channels
CAPACITY	12V - 96W maximum
	24V - 192W maximum
COMPATIBILITY	Compatible with LLI-C-CTRL-DMX controllers

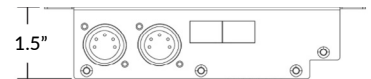
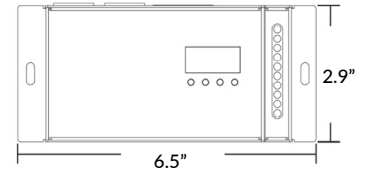

### FEATURES

Can be controlled by up to eight (8) controllers. Can be synchronized with twenty (20) decoders.

### POWER

Power supply not included. 12V/24V non-dimming power supply required.

# TUNABLE WHITE LED NEON - 24V

Mini Square Profile / Top Bending / Silicone (ST49)

DMX WALL CONTROLLERS (SOLD SEPARATELY)

## STAND ALONE DMX WALL CONTROLLER, GU2

### LLI-C-CTRL-DMX-STICK-GU2

INCLUDED IN PACKAGE	Controller, CD-ROM, USB cable, connector block, power supply
OS/COMPUTER REQUIREMENTS	Mac OSx 10.6 or higher / Windows XP or higher, USB 2.0 port
PROGRAM SOFTWARE	Easy Stand Alone, ESA2 (included)
CONNECTIONS	Power (2 pins), DMX (3 pins), Port (2 pins), Micro-USB Port
MOUNTING	Single or double gang wall box
IP RATING	IP20 - dry locations only

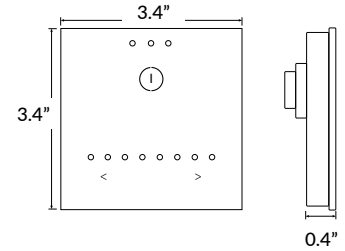

### FEATURES

- Up to 24 dynamic or static scenes
- Wall mounted control panel with glass face, touch-sensitive buttons
- Programmable with included USB cable and software – no Ethernet or WiFi required

## STAND ALONE DMX WALL CONTROLLER, DE3

### LLI-C-CTRL-DMX-STICK-DE3

INCLUDED IN PACKAGE	Controller, connector block, power supply
OS/COMPUTER REQUIREMENTS	Mac OSx 10.6 or higher / Windows XP or higher / iOS phone or tablet / Android phone or tablet
PROGRAM SOFTWARE	Easy Stand Alone, ESA2 (Mac/Windows) DMX Lightpad 3 App (iOS/Android) Easy Remote App (iOS/Android)
CONNECTIONS	Power/DMX - screw terminal and RJ45 compatible Memory - MicroSD slot Programming - MicroUSB port
POWER SUPPLY	6VDC power supply (included)
MEMORY	MicroSD card (not included)
MOUNTING	Single or double gang wall box
IP RATING	IP20 - dry locations only

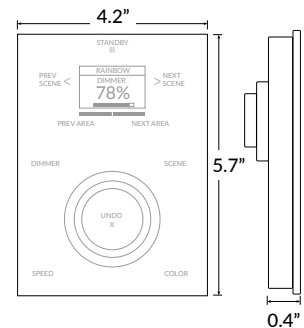
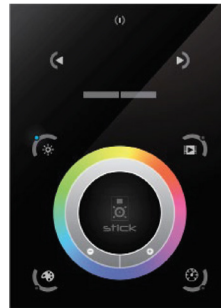

### FEATURES

- Multi-zone microSD memory
- Multi-room control with 500 scenes, 10 zones
- Integrated clock and calendar for scheduling events
- Touch-sensitive buttons
- USB and Ethernet connectivity for programming
- Windows/Mac software for programming dynamic effects
- iPhone/iPad/Android apps for remote control and program

# TUNABLE WHITE LED NEON - 24V

Mini Square Profile / Top Bending / Silicone (ST49)

DMX WALL CONTROLLERS (SOLD SEPARATELY)

## STAND ALONE DMX WALL CONTROLLER, CW4

<b>LLI-C-CTRL-DMX-STICK-CW4</b>	-		<b>FINISH</b>
			<b>BL</b> Black glass
			<b>WH</b> White glass

INCLUDED IN PACKAGE	Controller, connector block, power supply, mini-USB cable, ESA2 software, ESA Pro2 Software
OS/COMPUTER REQUIREMENTS	Mac OSx 10.6 or higher / Windows XP or higher
PROGRAM SOFTWARE	Easy Stand Alone, ESA2 (Mac/Windows)
CONNECTIONS	Power/DMX - screw terminal and RJ45 Programming - miniUSB port
POWER SUPPLY	Requires 5-10VDC 0.6A power supply (included)
MEMORY	Integrated flash memory
MOUNTING	Single or double gang wall box
IP RATING	IP20 - dry locations only



### FEATURES

- Can be controlled directly from a computer, smartphone, or tablet
- Touch-sensitive buttons, glass face
- Up to 36 dynamic or static scenes
- 8 port triggers
- 1024 DMX channels control up to 340 RGB fixtures
- Windows/Mac software for programming dynamic effects
- Internal clock and calendar with sunrise/sunset triggering

