

DUAL BEND STATIC WHITE LED NEON - 24V

Square Profile / Top and Side Bending / Silicone (SD63)

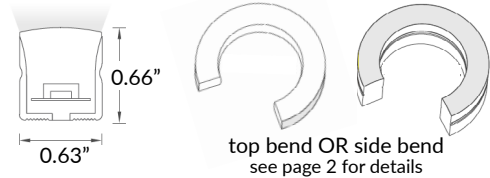

TECHNICAL INFORMATION

NOTE: All data has +/- 5% tolerance.

WATTAGE	4.6W per foot	
IP RATING	IP67 - wet locations. Protected against temporary submersion, limited protection against harsh environments.	
IK RATING	IK10	
BEAM ANGLE	118°	
HOUSING MATERIAL	Silicone, UV resistant per ISO 4892-3	
OUTPUT	CRI 80+	CRI 90+
	2700K - 244 lm/ft	2700K - 220 lm/ft
	3000K - 251 lm/ft	3000K - 226 lm/ft
	3500K - 264 lm/ft	3500K - 238 lm/ft
	4000K - 260 lm/ft	4000K - 234 lm/ft
	5000K - 267 lm/ft	5000K - 240 lm/ft
6500K - 263 lm/ft	6500K - 237 lm/ft	
INPUT VOLTAGE	24VDC	
SEGMENT LENGTH	Every 2.46", not field-cuttable	
MAXIMUM RUN	32 feet	
DIMENSIONS	0.63" W x 0.66" H	
MINIMUM BEND	7.9" diameter - top bending 19.7" diameter - side bending	
INSTALLATION TEMP.	32°F to 140°F (do not install when temperatures are below freezing)	
OPERATING TEMP.	-4°F to 140°F	
WARRANTY	3 year limited	
POWER SUPPLY	Compatible with all 24VDC power supplies - see page 3	

FEED TYPES

Product has 48in hard wire end feed unless otherwise specified. Other options subject to availability - contact us. Power Feed Caps and End Caps illuminate continuously to the end.

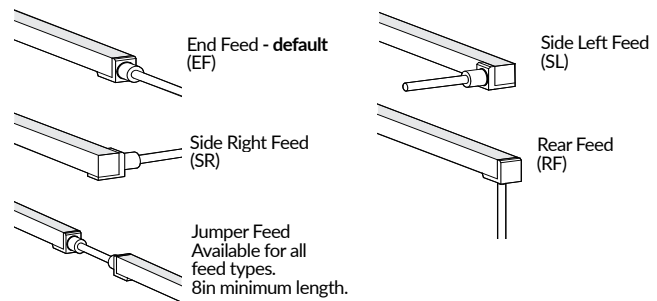

MOUNTING

See page 3 for details. 2 clips recommended per 12in of LED Neon. Sold separately.

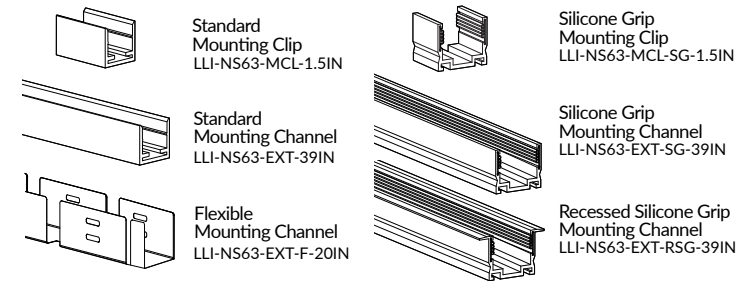

ORDERING GUIDE

SERIES	IP RATING	TYPE	COLOR	VOLTAGE	CRI	LENGTH
LLI-N4.6W	67	SD63		24V		
			27K		80	Enter total length in inches. Nominal length only. Actual lengths vary by cut point. Refer to page 3.
			30K		90	
			35K			
			40K			
			50K			
			65K			

← PRODUCT CODE

OPTIONAL CODE →

POWER FEED		
LEAD TYPE	LEAD LENGTH	FEED TYPE

Default [blank] - 48" hard wire end feed (PWR48EF)

PWR Hard Wire (no connector) Enter desired wire length in inches

EF End Feed
RF Rear Feed
SL Side Left
SR Side Right

For runs that require power feeds on both ends, repeat optional power feed code.

Example part number: LLI-N4.6W-67-SD63-30K-24V-80-96in
Default 48in end feed power wire (PWR48EF) included. Use OPTIONAL section to specify other power feed(s).

DUAL BEND STATIC WHITE LED NEON - 24V

Square Profile / Top and Side Bending / Silicone (SD63)

BEND ORIENTATION

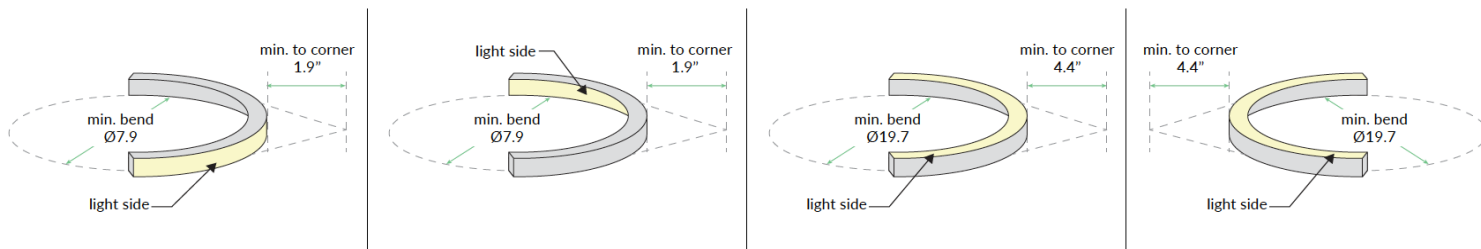

OVERALL LENGTH / SEGMENT GUIDE

Dimension tolerance of $\pm 1/8"$.

Measurements below do not include area required for routing power wire. Add 1" distance to layout to account for routing end feed power wire.

This product expands and contracts in varying ambient temperatures. If butting Neon end-to-end, add 1/2" to 1" gap between sections for expansion.

10.3"	12.8"	15.2"	17.7"	20.2"	22.6"	25.1"	27.5"	30.0"	32.5"	34.9"	37.4"
39.8"	42.3"	44.8"	47.2"	49.7"	52.1"	54.6"	57.1"	59.5"	62.0"	64.4"	66.9"
69.4"	71.8"	74.3"	76.8"	79.2"	81.7"	84.1"	86.6"	89.1"	91.5"	94.0"	96.4"
98.9"	101.4"	103.8"	106.3"	108.7"	111.2"	113.7"	116.1"	118.6"	121.0"	123.5"	126.0"
128.4"	130.9"	133.3"	135.8"	138.3"	140.7"	143.2"	145.6"	148.1"	150.6"	153.0"	155.5"
158.0"	160.4"	162.9"	165.3"	167.8"	170.3"	172.7"	175.2"	177.6"	180.1"	182.6"	185.0"
187.5"	189.9"	192.4"	194.9"	197.3"	199.8"	202.2"	204.7"	207.2"	209.6"	212.1"	214.5"
217.0"	219.5"	221.9"	224.4"	226.9"	229.3"	231.8"	234.2"	236.7"	239.2"	241.6"	244.1"
246.5"	249.0"	251.5"	253.9"	256.4"	258.8"	261.3"	263.8"	266.2"	268.7"	271.1"	273.6"
276.1"	278.5"	281.0"	283.4"	285.9"	288.4"	290.8"	293.3"	295.7"	298.2"	300.7"	303.1"
305.6"	308.1"	310.5"	313.0"	315.4"	317.9"	320.4"	322.8"	325.3"	327.7"	330.2"	332.7"
335.1"	337.6"	340.0"	342.5"	345.0"	347.4"	349.9"	352.3"	354.8"	357.3"	359.7"	362.2"
364.6"	367.1"	369.6"	372.0"	374.5"	376.9"	379.4"	381.9"	384.3"	386.8"	389.3"	391.7"

DUAL BEND STATIC WHITE LED NEON - 24V

Square Profile / Top and Side Bending / Silicone (SD63)

ANTI-WICKING FERRULE

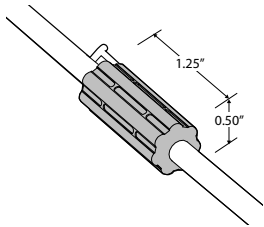

Standard on all LED Neon power feeds. Located 4-6" from the connector. Protects against water ingress and circuit board corrosion.

MOUNTING CHANNELS AND CLIPS (SOLD SEPARATELY)

NOTE: Leave a 0.5" to 1" gap between Neon power feed and mounting channel, to avoid undue stress on power feed cables.

ALUMINUM MOUNTING CHANNEL - SILVER ANODIZED

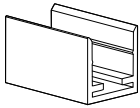

Mounting Clip

Recommended 2 clips every 12"

Part Number: LLI-NS63-MCL-1.5IN

Dimensions: 1.50" L x 0.75" H x 0.84" W

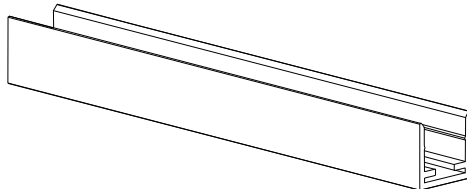

39" Mounting Channel

Part Number: LLI-NS63-EXT-39IN

Dimensions: 39" L x 0.75" H x 0.84" W

ALUMINUM MOUNTING CHANNEL WITH SILICONE GRIP - SILVER ANODIZED

Recommended for ceilings or downward mounted Neon.

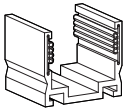

Silicone Grip Mounting Clip

Recommended 2 clips every 12"

Part Number: LLI-NS63-MCL-SG-1.5IN

Dimensions: 1.50" L x 0.82" H x 0.83" W

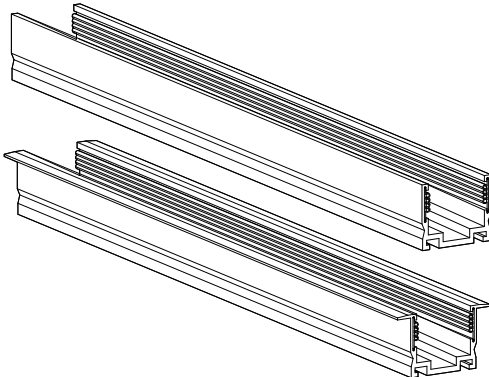

39" Silicone Grip Mounting Channel

Part Number: LLI-NS63-EXT-SG-39IN

Dimensions: 39" L x 0.82" H x 0.83" W

39" Recessed Silicone Grip Mounting Channel

Part Number: LLI-NS63-EXT-RSG-39IN

Dimensions: 39" L x 0.82" H x 1.20" W

FLEXIBLE ALUMINUM MOUNTING CHANNEL - WHITE POWDER COAT

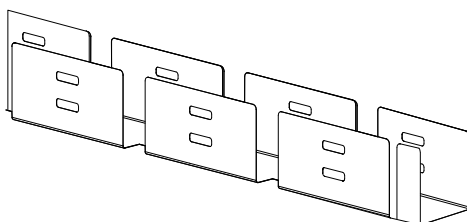

20" Flexible Mounting Channel

Part Number: LLI-NS63-EXT-F-20IN

Dimensions: 20" L x 0.71" H x 0.69" W

POWER SUPPLIES SOLD SEPARATELY

DIMMABLE ELECTRONIC 0-10V

Optimal performance dims to 0%.*



PART NUMBER	CAPACITY	INPUT	OUTPUT	CLASS	LOCATION	L	W	H
LLI-PS-DE010-030W-24V-KO	30W	120/277V	24V	CLASS 2	IP66 WET	6.5"	3.6"	1.6"
LLI-PS-DE010-060W-24V-KO	60W	120/277V	24V	CLASS 2	IP66 WET	7.4"	3.6"	1.6"
LLI-PS-DE010-096W-24V-KO	96W	120/277V	24V	CLASS 2	IP66 WET	8.7"	3.7"	1.7"
LLI-PS-DE010-200W-24V-KO	200W	120/277V	24V	CLASS 1	IP66 WET	10.2"	4.1"	1.8"
LLI-PS-DE010-300W-24V-KO	300W	120/277V	24V	CLASS 1	IP66 WET	10.9"	4.3"	1.8"

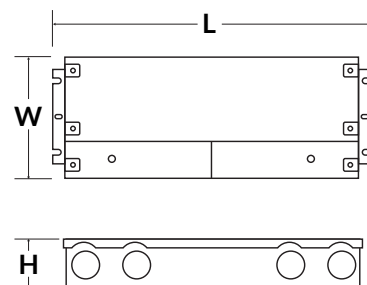

NON-DIMMABLE ELECTRONIC



PART NUMBER	CAPACITY	INPUT	OUTPUT	CLASS	LOCATION	L	W	H
LLI-PS-NDE-030W-24V-KO	30W	100-277V	24V	CLASS 2	IP66 WET	6.5"	3.5"	1.02"
LLI-PS-NDE-060W-24V-KO	60W	100-277V	24V	CLASS 2	IP66 WET	7.4"	3.5"	1.2"
LLI-PS-NDE-096W-24V-KO	96W	100-277V	24V	CLASS 2	IP66 WET	8.7"	3.7"	1.7"
LLI-PS-NDE-200W-24V-KO	200W	100-277V	24V	CLASS 1	IP66 WET	10.3"	4.1"	1.8"
LLI-PS-NDE-300W-24V-KO	300W	100-277V	24V	CLASS 1	IP66 WET	10.9"	4.3"	1.8"

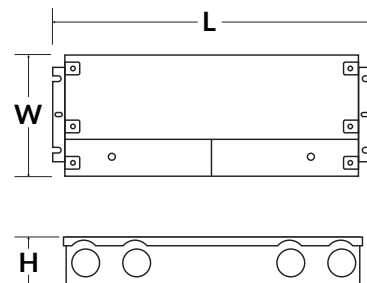

DIMMABLE ELECTRONIC FLICKER-FREE

Optimal performance dims to 2-5%.



PART NUMBER	CAPACITY	INPUT	OUTPUT	CLASS	LOCATION	L	W	H
LLI-PS-UDEFF-030W-24V-KO	30W	110-277V	24V	CLASS 2	IP66 WET	6.5"	3.6"	1.0"
LLI-PS-UDEFF-060W-24V-KO	60W	110-277V	24V	CLASS 2	IP66 WET	7.4"	3.6"	1.0"
LLI-PS-UDEFF-096W-24V-KO	96W	110-277V	24V	CLASS 2	IP66 WET	8.7"	3.7"	1.6"
LLI-PS-UDEFF-200W-24V-KO	200W	110-277V	24V	CLASS 1	IP66 WET	10.2"	4.1"	1.8"
LLI-PS-UDEFF-300W-24V-KO	300W	110-277V	24V	CLASS 1	IP66 WET	11.0"	4.3"	1.8"

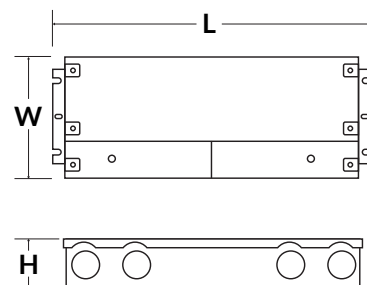

DIMMABLE MAGNETIC

Optimal performance dims to 5-10%.*



PART NUMBER	CAPACITY	INPUT	OUTPUT	CLASS	LOCATION	L	W	H
LLI-PS-DM-020W-24V-KO	20W	120/277V	24V	CLASS 2	NEMA 3R WET	7.38"	2.11"	1.60"
LLI-PS-DM-040W-24V-KO	40W	120/277V	24V	CLASS 2	NEMA 3R WET	7.38"	2.11"	1.60"
LLI-PS-DM-060W-24V-KO	60W	120/277V	24V	CLASS 2	NEMA 3R WET	8.13"	3.93"	1.59"
LLI-PS-DM-100W-24V-KO	100W	120/277V	24V	CLASS 2	NEMA 3R WET	8.13"	3.93"	1.59"
LLI-PS-DM-150W-24V-KO	150W	120/277V	24V	CLASS 1	NEMA 3R WET	8.79"	4.15"	3.41"
LLI-PS-DM-200W-24V-KO	200W	120/277V	24V	CLASS 1	NEMA 3R WET	8.79"	4.15"	3.41"
LLI-PS-DM-300W-24V-KO	300W	120/277V	24V	CLASS 1	NEMA 3R WET	8.79"	4.15"	3.41"
LLI-PS-DM-300W-24V-CL2-KO	6 x 50W	120/277V	24V	CLASS 2	NEMA 3R WET	10.29"	5.69"	3.43"
LLI-PS-DM-600W-24V-KO	2 x 300W	120/277V	24V	CLASS 1	NEMA 3R WET	10.29"	6.79"	4.68"

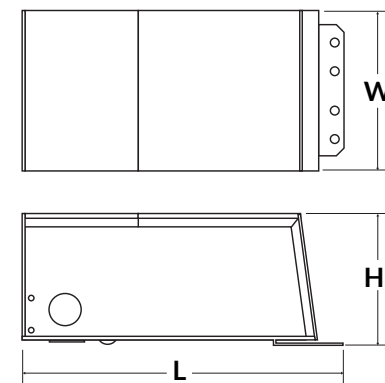

LUTRON HI-LUME PREMIER 0.1% DIMMABLE ELECTRONIC

Soft-on, Fade-to-Black, continuous flicker-free dimming from 100% to 0.1.



PART NUMBER	CAPACITY	INPUT	OUTPUT	CLASS	LOCATION	L	W	H
L3D0-96W24V-U	96W	120-277V	24V	CLASS 2	IP20 DRY	10.5"	5.5"	2.0"

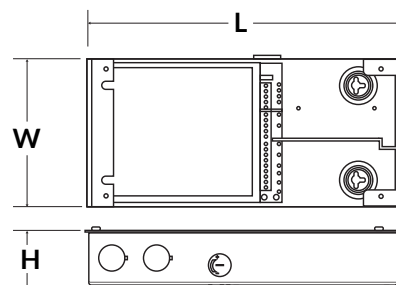

*Performance can be affected by driver loading and dimmer type.