

COLOR CHANGING RGBW LED NEON - 24V

Dome Profile / Side Bending / Silicone

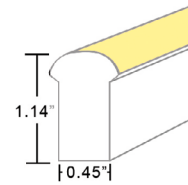
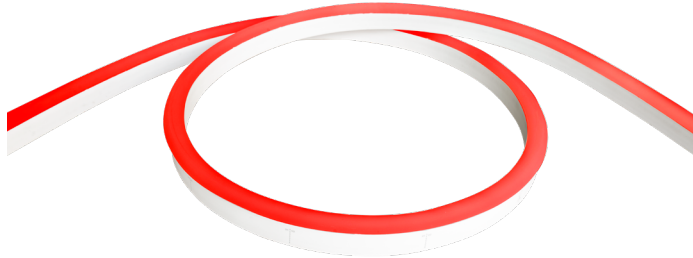

TECHNICAL INFORMATION

NOTE: All data has +/- 5% tolerance.

WATTAGE	4.6W per foot
IP RATING	IP68 - wet locations. Protected against temporary submersion, limited protection against harsh environments.
PROFILE	Dome
BEND ORIENTATION	Side Bending
HOUSING MATERIAL	Silicone, UV resistant per ISO 4892-3
OUTPUT	Red (618-624nm) - 18 lm/ft Green (522-528nm) - 43 lm/ft Blue (468-474nm) - 9 lm/ft 2700K - 43 lm/ft 3000K - 50 lm/ft 4000K - 56 lm/ft
INPUT VOLTAGE	24VDC
SEGMENT LENGTH	Every 3.9", not field-cuttable
MAXIMUM RUN	16 feet (single feed power)
DIMENSIONS	0.45" W x 1.14" H (11.5mm x 29mm)
MINIMUM BEND	4.72" diameter
INSTALLATION TEMP.	-40°F to 140°F
OPERATING TEMP.	-40°F to 140°F
WARRANTY	3 year limited
CONTROLS	Color and intensity can be adjusted with DMX decoder or RF receiver and controller
POWER SUPPLY	Compatible with all 24VDC non-dimming power supplies -- see page 8

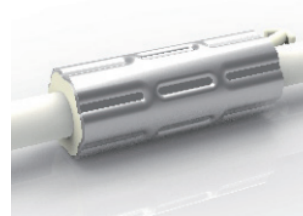

ANTI-WICKING FERRULE

Standard on all LED Neon power cables. Located 4.5" from the connector. Protects against water ingress and circuit board corrosion. H 0.47" x W 1.18"

MOUNTING CLIP OPTIONS (SOLD SEPARATELY)

More options and channels available (page 5-7). Recommended 2 clips per 12" of Neon.

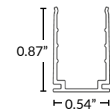

Mounting Clip

Part Number: LLI-ND-MCL-1.5IN
1.38" L x 0.87" H x 0.54" W

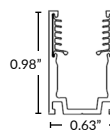

Silicone Grip Mounting Clip

Part Number: LLI-ND-MCL-SG-0.8IN
0.80" L x 0.98" H x 0.63" W

NOTE: Neon sections may be mounted end-to-end on the non-power feed end to create the appearance of longer runs. End-to-end Neon sections must have a 0.5" to 1" gap to allow for expansion/contraction. A dark spot may be visible at <20ft viewing distance.

PART NUMBER BUILDER / ORDERING GUIDE

Example part number: LLI-N4.6W-68-DSS-R27-24V-96in

SERIES	IP RATING	TYPE	CCT	VOLTAGE	LENGTH
LLI-N4.6W	68	DSS	<input type="text"/>	24V	<input type="text"/>
			R27 R30 R40		(enter length in inches, up to 587")

COLOR CHANGING RGBW LED NEON - 24V

Dome Profile / Side Bending / Silicone

ORIENTATION & MINIMUM BEND DIAMETER

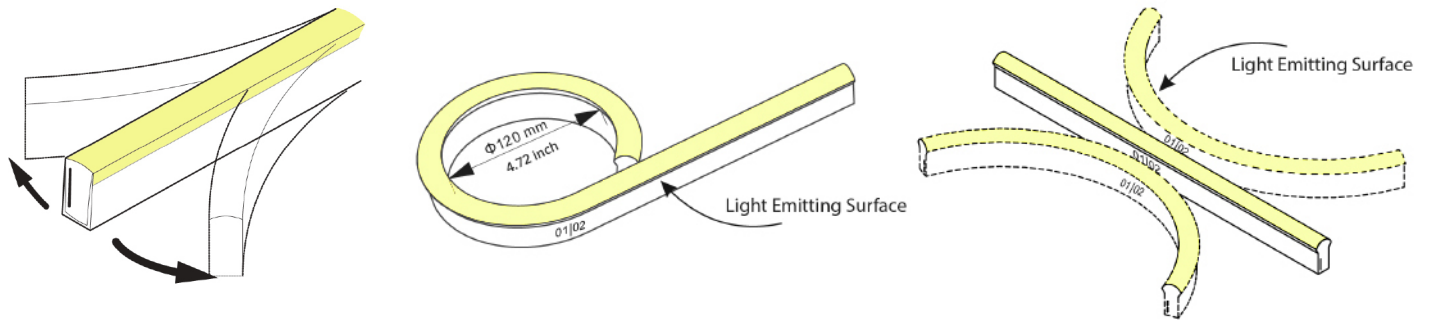

POWER FEED ORIENTATION GUIDE

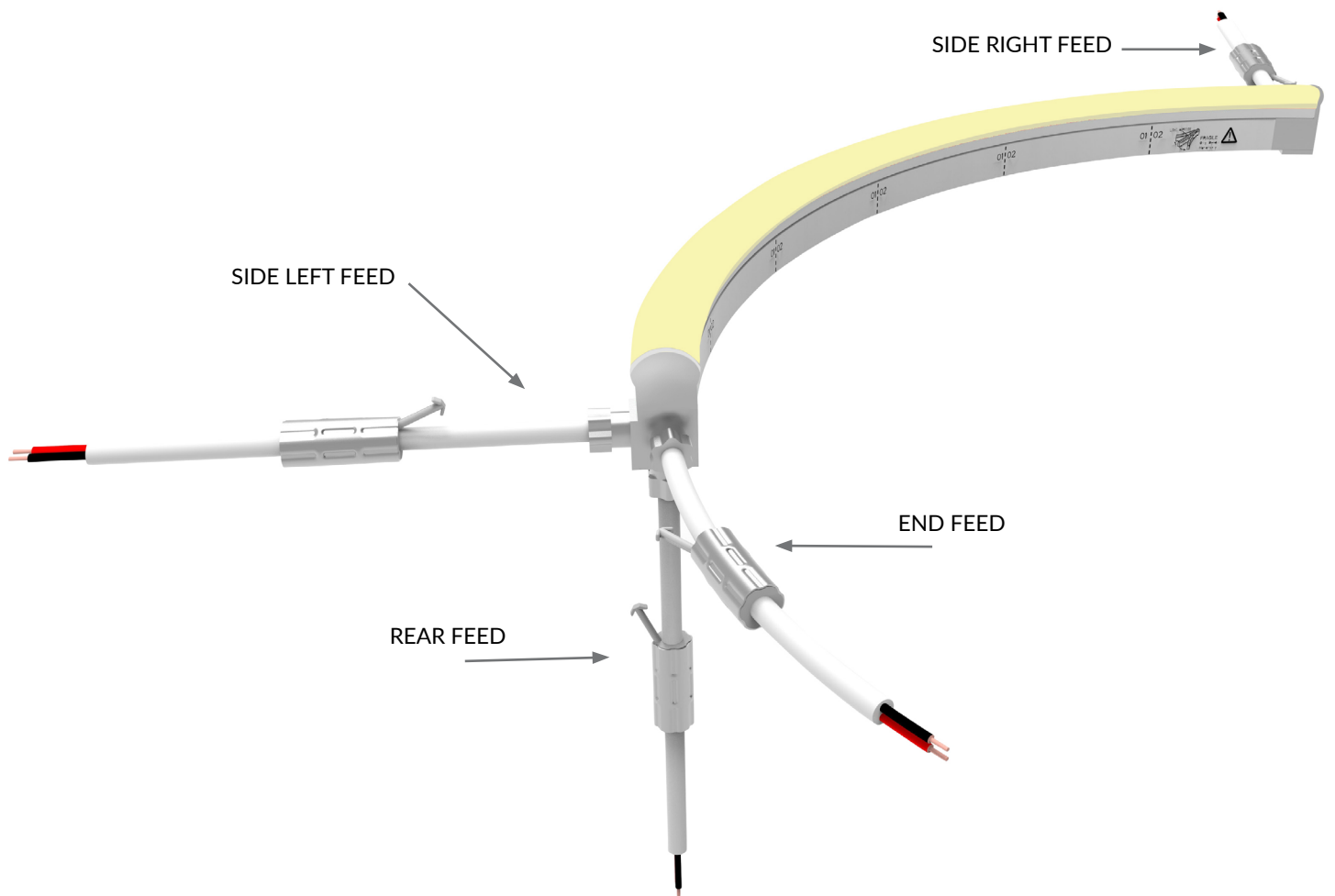

COLOR CHANGING RGBW LED NEON - 24V

Dome Profile / Side Bending / Silicone

POWER FEED & TERMINATION OPTIONS (IP68)

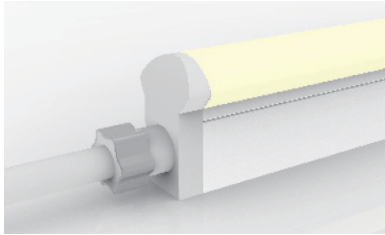

End Power Feed

SERIES	LENGTH
LLI-ND-68-PWR5-EF	39IN 118IN 196IN 393IN

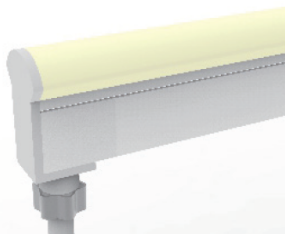
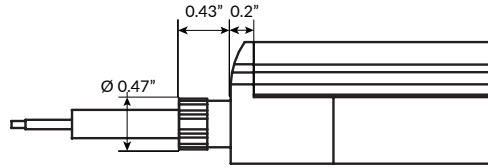
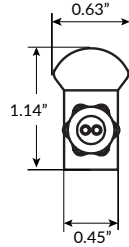

Rear Power Feed

SERIES	LENGTH
LLI-ND-68-PWR5-RF	39IN 118IN 196IN 393IN

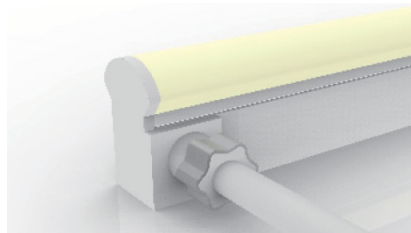
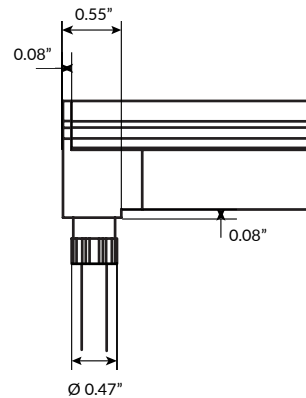
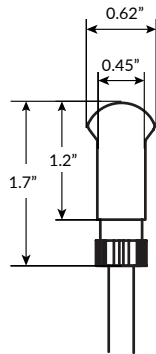

Side Right Power Feed

SERIES	SIDE	LENGTH
LLI-ND-68-PWR5	SR	39IN 118IN 196IN 393IN

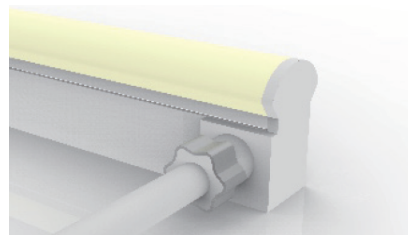

Side Left Power Feed

SERIES	SIDE	LENGTH
LLI-ND-68-PWR5	SL	39IN 118IN 196IN 393IN

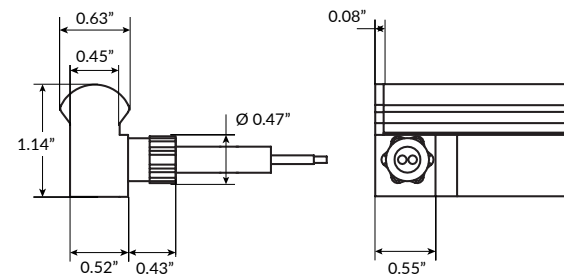

COLOR CHANGING RGBW LED NEON - 24V

Dome Profile / Side Bending / Silicone

POWER FEED & TERMINATION OPTIONS (IP68)

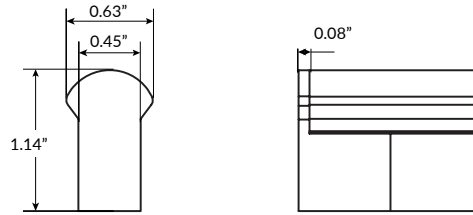
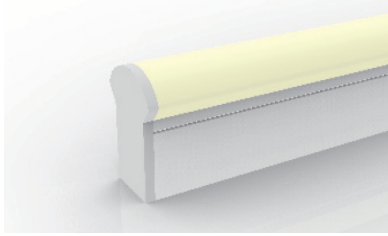

End Cap

SERIES

LLI-ND-68-EC

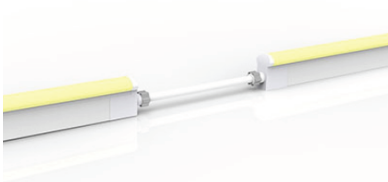

Jumper Power Connector (maximum 4 per run)

SERIES SIDE LENGTH (L)

LLI-ND-68-CON5

SR	12IN
SL	39IN
EF	118IN
RF	196IN
	393IN

COLOR CHANGING RGBW LED NEON - 24V

Dome Profile / Side Bending / Silicone

OVERALL LENGTH / CUT POINT GUIDE

Dimension tolerance of $\pm 1/8"$. Measurements listed below apply to Side Feed and Rear Feed Neon only. Add 1" to measurements below for End Feed Neon. Measurements below do not include area required for routing power wire. Add 1" distance to layout to account for routing end feed power wire. This product expands and contracts in varying ambient temperatures. If butting Neon end-to-end, add 1/2" to 1" gap between sections for expansion.

8.2"	12.1"	16.0"	20.0"	23.9"	27.9"	31.8"	35.7"	39.7"	43.6"	47.6"	51.5"
55.4"	59.4"	63.3"	67.3"	71.2"	75.1"	79.1"	83.0"	87.0"	90.9"	94.8"	98.8"
102.7"	106.7"	110.6"	114.5"	118.5"	122.4"	126.4"	130.3"	134.2"	138.2"	142.1"	146.1"
150.0"	153.9"	157.9"	161.8"	165.8"	169.7"	173.6"	177.6"	181.5"	185.5"	189.4"	193.3"
197.3"											

MOUNTING CHANNELS

NOTE: Leave a 0.5" to 1" gap between Neon power feed and mounting channel, to avoid undue stress on power feed cables.

ALUMINUM MOUNTING CHANNEL

Silver anodized finish

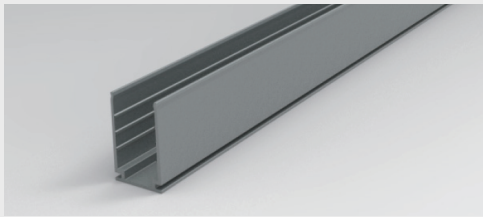

Mounting Clip

Recommended 2 clips every 12"

Part Number: LLI-ND-MCL-1.5IN
Dimensions: 1.5" L x 0.87" H x 0.54" W

20" Mounting Channel

Part Number: LLI-ND-EXT-20IN
Dimensions: 20" L x 0.87" H x 0.54" W

39" Mounting Channel

Part Number: LLI-ND-EXT-39IN
Dimensions: 39" L x 0.87" H x 0.54" W

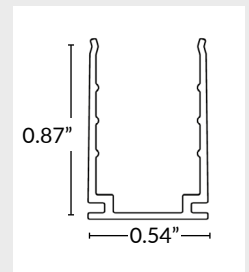

SILICONE GRIP ALUMINUM MOUNTING CHANNEL

Recommended for ceiling and wall applications

Silver anodized finish

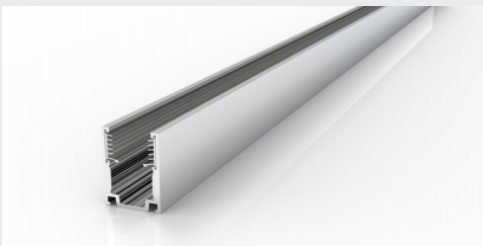

Mounting Clip

Recommended 2 clips every 12"

Part Number: LLI-ND-MCL-SG-0.8IN
Dimensions: 0.8" L x 0.98" H x 0.63" W

20" Mounting Channel

Part Number: LLI-ND-EXT-SG-20IN
Dimensions: 20" L x 0.98" H x 0.63" W

39" Mounting Channel

Part Number: LLI-ND-EXT-SG-39IN
Dimensions: 39.4" L x 0.98" H x 0.63" W

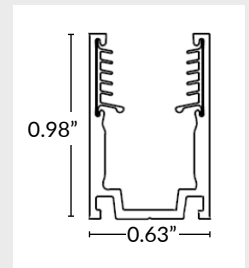

COLOR CHANGING RGBW LED NEON - 24V

Dome Profile / Side Bending / Silicone

MOUNTING CHANNELS

NOTE: Leave a 0.5" to 1" gap between Neon power feed and mounting channel, to avoid undue stress on power feed cables.

PLASTIC MOUNTING CHANNEL

White finish

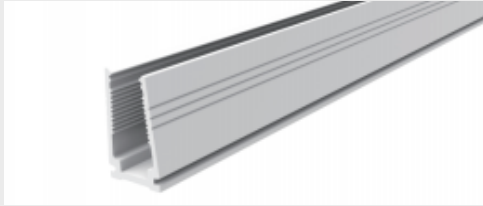

20" Mounting Channel

Part Number: LLI-NS-EXT-P-20IN
Dimensions: 20" L x 0.94" H x 0.55" W

39" Mounting Channel

Part Number: LLI-NS-EXT-P-39IN
Dimensions: 39.4" L x 0.94" H x 0.55" W

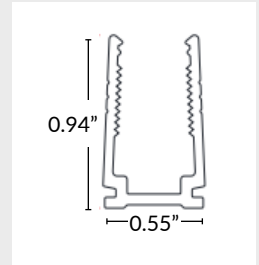

REINFORCED PLASTIC MOUNTING CHANNEL

Clear plastic

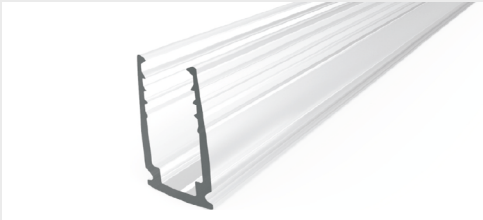

1.5" Mounting Clip

Part Number: LLI-ND-EXT-CP-1.5IN
Dimensions: 1.5" L x 1.03" H x 0.62" W

20" Mounting Channel

Part Number: LLI-ND-EXT-CP-20IN
Dimensions: 20" L x 1.03" H x 0.62" W

39" Mounting Channel

Part Number: LLI-ND-EXT-CP-39IN
Dimensions: 39.4" L x 1.03" H x 0.62" W

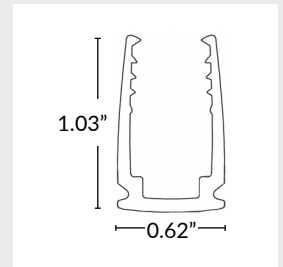

FLEXIBLE STAINLESS STEEL MOUNTING CHANNEL

Silver anodized finish



4" Mounting Channel

Part Number: LLI-ND-EXT-F-4IN
Dimensions: 4" L x 0.97" H x 0.52" W

12" Mounting Channel

Part Number: LLI-ND-EXT-F-12IN
Dimensions: 12" L x 0.97" H x 0.52" W

20" Mounting Channel

Part Number: LLI-ND-EXT-F-20IN
Dimensions: 20" L x 0.97" H x 0.52" W

35" Mounting Channel

Part Number: LLI-ND-EXT-F-35IN
Dimensions: 35" L x 0.97" H x 0.52" W

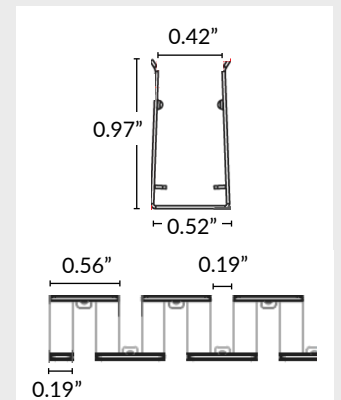

BENDABLE SERRATED ALUMINUM MOUNTING CHANNEL

Silver anodized finish

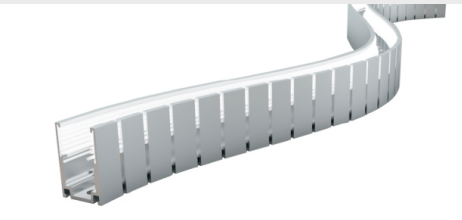

20" Mounting Channel

Part Number: LLI-ND-EXT-BS-20IN
Dimensions: 20" L x 0.98" H x 0.63" W

39" Mounting Channel

Part Number: LLI-ND-EXT-BS-39IN
Dimensions: 39.4" L x 0.98" H x 0.63" W

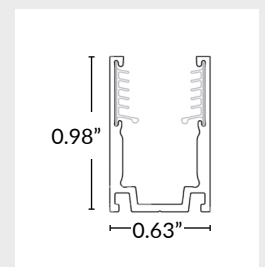

COLOR CHANGING RGBW LED NEON - 24V

Dome Profile / Side Bending / Silicone

MOUNTING CHANNELS

NOTE: Leave a 0.5" to 1" gap between Neon power feed and mounting channel, to avoid undue stress on power feed cables.

RECESSED ALUMINUM MOUNTING CHANNEL

Silver anodized finish



0.8" Mounting Clip

Part Number: LLI-ND-EXT-R-0.8IN
Dimensions: 0.8" L x 0.94" H x 0.79" W

20" Mounting Channel

Part Number: LLI-ND-EXT-R-20IN
Dimensions: 20" L x 0.94" H x 0.79" W

39" Mounting Channel

Part Number: LLI-ND-EXT-R-39IN
Dimensions: 39.4" L x 0.94" H x 0.79" W

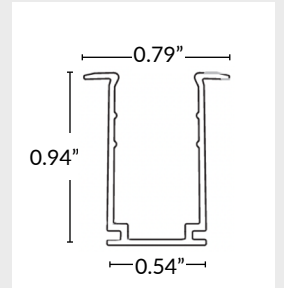

RECESSED ALUMINUM MOUNTING CHANNEL WITH SILICONE GRIP

Recommended for ceiling and wall applications

Silver anodized finish



0.8" Mounting Clip

Part Number: LLI-ND-MCL-RSG-0.8IN
Dimensions: 0.8" L x 0.98" H x 1.0" W

20" Mounting Channel

Part Number: LLI-ND-EXT-RSG-20IN
Dimensions: 20" L x 0.98" H x 1.0" W

39" Mounting Channel

Part Number: LLI-ND-EXT-RSG-39IN
Dimensions: 39.4" L x 0.98" H x 1.0" W

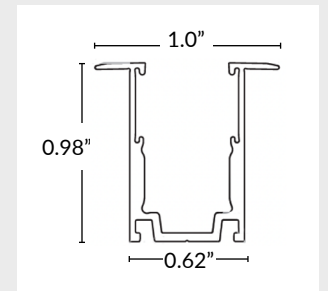

ADJUSTABLE MOUNTING BRACKET

Recommended 3 brackets for every 39" channel

Adjusts in 15° increments, notches every 30°



Part Number: LLI-ND-BKT-ADJ
Dimensions: 1" L x 1.6" H x 1.8" W

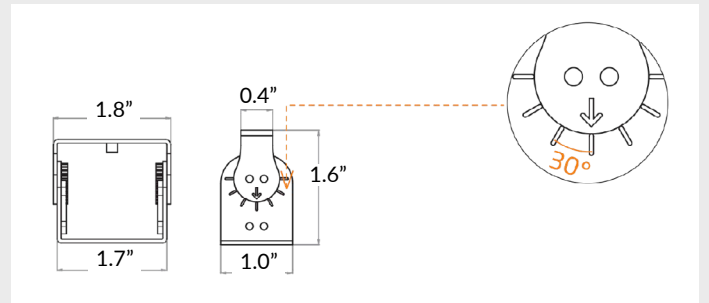

SIDE MOUNTING BRACKET

Recommended 2 brackets for every 20" or 39" channel

Not compatible with mounting clips



Part Number: LLI-ND-BKT-90D
Dimensions: 0.8" L x 2.8" H x 1.0" W

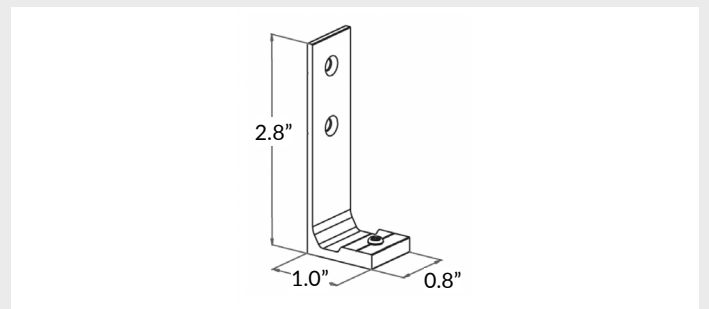

COLOR CHANGING RGBW LED NEON - 24V

Dome Profile / Side Bending / Silicone

POWER SUPPLY (SOLD SEPARATELY)

NON-DIMMABLE ELECTRONIC



PART NUMBER	CAPACITY	INPUT	OUTPUT	CLASS	LOCATION	L	W	H
LLI-PS-NDE-030W-24V-KO	30W	100-277V	24V	CLASS 2	IP66 WET	6.5"	3.5"	1.02"
LLI-PS-NDE-060W-24V-KO	60W	100-277V	24V	CLASS 2	IP66 WET	7.4"	3.5"	1.2"
LLI-PS-NDE-096W-24V-KO	96W	100-277V	24V	CLASS 2	IP66 WET	8.7"	3.7"	1.7"
LLI-PS-NDE-192W-24V-CL2-KO	2x96W	100-277V	24V	CLASS 2	IP66 WET	10.9"	4.1"	1.9"
LLI-PS-NDE-200W-24V-KO	200W	100-277V	24V	CLASS 1	IP66 WET	10.3"	4.1"	1.8"
LLI-PS-NDE-288W-24V-CL2-KO	3x96W	100-277V	24V	CLASS 2	IP66 WET	11.9"	4.1"	1.9"
LLI-PS-NDE-300W-24V-KO	300W	100-277V	24V	CLASS 1	IP66 WET	10.9"	4.3"	1.8"

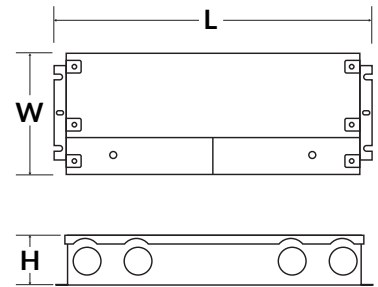

RF RECEIVER (SOLD SEPARATELY)

LLI-C-RCV-UR-RF-4CH

CONTROLLER COMPATIBILITY	Compatible with all RF LLI-C-CTRL controllers.
LED COMPATIBILITY	Static Color, Tunable White & RGB(W) LEDs
CHANNELS	4 Channel, 8 Amp
INPUT VOLTAGE	12V / 24V (power supply not included)
CAPACITY	12V - 96W, 24V - 192W
FEATURES	Can be controlled by up to (8) controllers Can be synchronized with unlimited receivers up to 320ft away

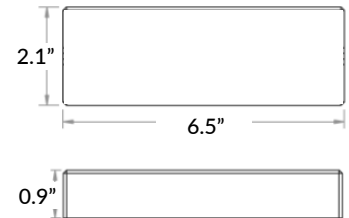
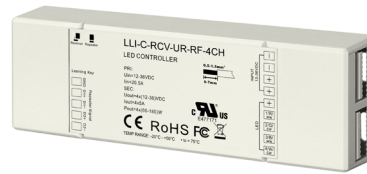

COLOR CHANGING RGBW LED NEON - 24V

Dome Profile / Side Bending / Silicone

RF CONTROLLERS (SOLD SEPARATELY)

REMOTE CONTROLLER

LLI-C-CTRL-RGBW-HH

RECEIVER COMPATIBILITY	Compatible with Universal RF receivers
LED COMPATIBILITY	RGB(W) LEDs
INPUT VOLTAGE	Battery operated (3 AAA batteries not included)
FEATURES	<ul style="list-style-type: none"> Programmable up to 4 zones, 3 scenes Color adjustment Light intensity adjustment

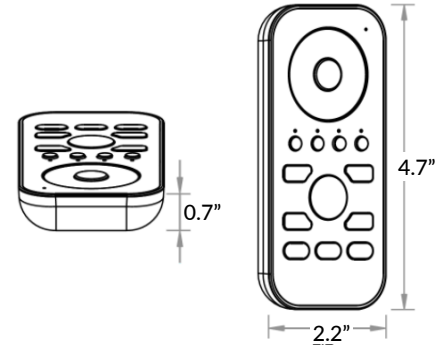

TOUCH PANEL WALL CONTROLLER

LLI-C-CTRL-RGBW-TP-WH

RECEIVER COMPATIBILITY	Compatible with Universal RF receivers
LED COMPATIBILITY	RGB(W) LEDs
INPUT VOLTAGE	12V DC power supply required (not included)
FEATURES	<ul style="list-style-type: none"> Control range ≥ 65ft Programmable up to 3 scenes 4 color presets Color adjustment Light intensity adjustment

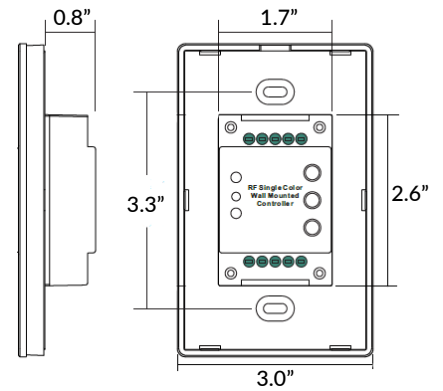
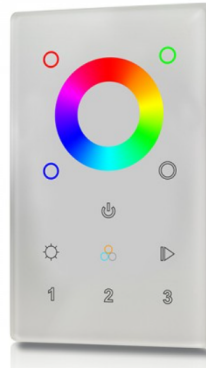

COLOR CHANGING RGBW LED NEON - 24V

Dome Profile / Side Bending / Silicone

DMX DECODERS (SOLD SEPARATELY)

DMX512 DECODER

LLI-C-DEC-DMX512-8A

LOCATION RATING	Indoor only
FUNCTION	Static color, tunable white, RGB(W) LEDs
CHANNELS	4 channel output, 8 Amp maximum 512 addressable DMX channels
CAPACITY	12V - 96W maximum 24V - 192W maximum
COMPATIBILITY	Compatible with LLI-C-CTRL-DMX controllers

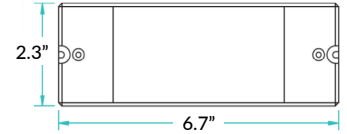

POWER

Power supply not included. 12V/24V non-dimming power supply required.

RDM DMX512 DECODER

LLI-C-DEC-DMX512-8A-RDM

OUTPUT	8A maximum, 4 channels
LOCATION RATING	Indoor only
FUNCTION	RDM communication and PWM dimming for static white, static color, tunable white, and RGB(W) LEDs
CHANNELS	4 channel output, 8 Amp maximum 512 addressable DMX channels
CAPACITY	12V - 96W maximum 24V - 192W maximum
COMPATIBILITY	Compatible with LLI-C-CTRL-DMX controllers

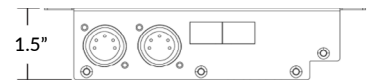
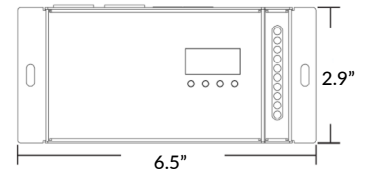

FEATURES

Can be controlled by up to eight (8) controllers. Can be synchronized with twenty (20) decoders.

POWER

Power supply not included. 12V/24V non-dimming power supply required.

COLOR CHANGING RGBW LED NEON - 24V

Dome Profile / Side Bending / Silicone

DMX WALL CONTROLLERS (SOLD SEPARATELY)

STAND ALONE DMX WALL CONTROLLER, GU2

LLI-C-CTRL-DMX-STICK-GU2

INCLUDED IN PACKAGE	Controller, CD-ROM, USB cable, connector block, power supply
OS/COMPUTER REQUIREMENTS	Mac OSx 10.6 or higher / Windows XP or higher, USB 2.0 port
PROGRAM SOFTWARE	Easy Stand Alone, ESA2 (included)
CONNECTIONS	Power (2 pins), DMX (3 pins), Port (2 pins), Micro-USB Port
MOUNTING	Single or double gang wall box
IP RATING	IP20 - dry locations only

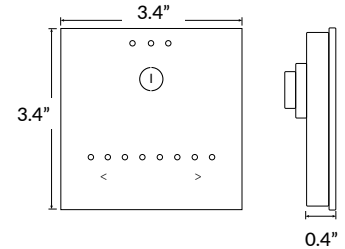

FEATURES

- Up to 24 dynamic or static scenes
- Wall mounted control panel with glass face, touch-sensitive buttons
- Programmable with included USB cable and software – no Ethernet or WiFi required

STAND ALONE DMX WALL CONTROLLER, DE3

LLI-C-CTRL-DMX-STICK-DE3

INCLUDED IN PACKAGE	Controller, connector block, power supply
OS/COMPUTER REQUIREMENTS	Mac OSx 10.6 or higher / Windows XP or higher / iOS phone or tablet / Android phone or tablet
PROGRAM SOFTWARE	Easy Stand Alone, ESA2 (Mac/Windows) DMX Lightpad 3 App (iOS/Android) Easy Remote App (iOS/Android)
CONNECTIONS	Power/DMX - screw terminal and RJ45 compatible Memory - MicroSD slot Programming - MicroUSB port
POWER SUPPLY	6VDC power supply (included)
MEMORY	MicroSD card (not included)
MOUNTING	Single or double gang wall box
IP RATING	IP20 - dry locations only

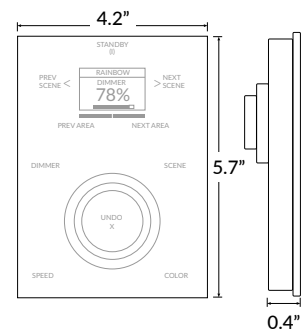
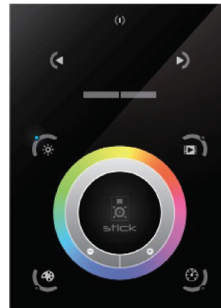

FEATURES

- Multi-zone microSD memory
- Multi-room control with 500 scenes, 10 zones
- Integrated clock and calendar for scheduling events
- Touch-sensitive buttons
- USB and Ethernet connectivity for programming
- Windows/Mac software for programming dynamic effects
- iPhone/iPad/Android apps for remote control and program

COLOR CHANGING RGBW LED NEON - 24V

Dome Profile / Side Bending / Silicone

DMX WALL CONTROLLERS (SOLD SEPARATELY)

STAND ALONE DMX WALL CONTROLLER, CW4

LLI-C-CTRL-DMX-STICK-CW4 -

FINISH

BL Black glass

WH White glass

INCLUDED IN PACKAGE

Controller, connector block, power supply, mini-USB cable, ESA2 software, ESA Pro2 Software

OS/COMPUTER REQUIREMENTS

Mac OSx 10.6 or higher / Windows XP or higher

PROGRAM SOFTWARE

Easy Stand Alone, ESA2 (Mac/Windows)

CONNECTIONS

Power/DMX - screw terminal and RJ45 Programming - miniUSB port

POWER SUPPLY

Requires 5-10VDC 0.6A power supply (included)

MEMORY

Integrated flash memory

MOUNTING

Single or double gang wall box

IP RATING

IP20 - dry locations only

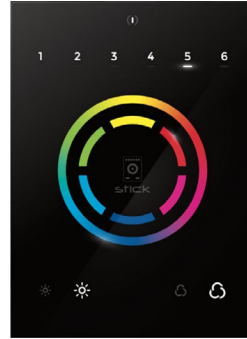

FEATURES

- Can be controlled directly from a computer, smartphone, or tablet
- Touch-sensitive buttons, glass face
- Up to 36 dynamic or static scenes
- 8 port triggers
- 1024 DMX channels control up to 340 RGB fixtures
- Windows/Mac software for programming dynamic effects
- Internal clock and calendar with sunrise/sunset triggering

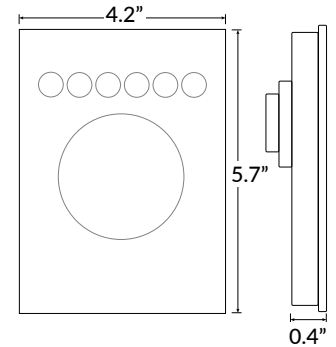

TOUCH PANEL DMX WALL CONTROLLER

LLI-C-CTRL-DMX-RGBW-TP

LED TAPE COMPATIBILITY

Compatible with 12-24V DC LED tapes

PROTOCOL

DMX512

ZONES

3 zones

INTERFACE

Glass touch control

WARRANTY

5 year limited

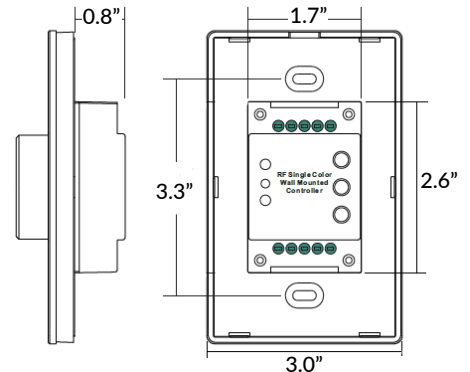
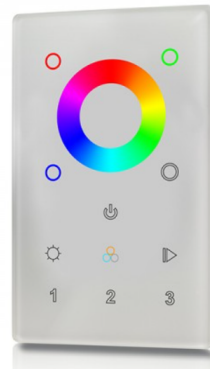

POWER

Power supply for controller not included. 12V DC power supply required.