

# COLOR CHANGING RGBW LED NEON - 24V

Square Profile, 3 Illuminated Sides / Top Bending / Silicone

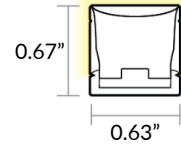
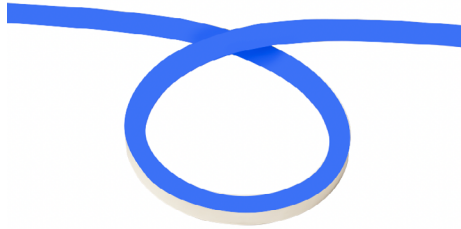

## TECHNICAL INFORMATION

NOTE: All data has +/- 5% tolerance.

WATTAGE	4.6W per foot
IP RATING	IP68 - wet locations. Protected against temporary submersion, limited protection against harsh environments.
PROFILE	Square, 3 illuminated sides
BEND ORIENTATION	Top Bending
HOUSING MATERIAL	Silicone, UV resistant per ISO 4892-3
OUTPUT	Red (618-624nm) - 38 lm/ft Green (522-528nm) - 107 lm/ft Blue (468-474nm) - 21 lm/ft 2700K - 87 lm/ft 3000K - 91 lm/ft 4000K - 105 lm/ft
CRI	80+
INPUT VOLTAGE	24VDC
SEGMENT LENGTH	Every 3.3", not field-cuttable
MAXIMUM RUN	26 feet
DIMENSIONS	0.63" W x 0.67" H (16mm x 17mm)
MINIMUM BEND	12" diameter
INSTALLATION TEMP.	-40°F to 140°F
OPERATING TEMP.	-40°F to 140°F
WARRANTY	3 year limited
CONTROLS	Receiver/decoder and controller required.
POWER SUPPLY	Compatible with all non-dimmable 24VDC power supplies - see power supply section of website.

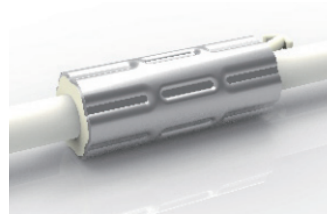

### ANTI-WICKING FERRULE

Standard on all LED Neon power cables. Located 4.5" from the connector. Protects against water ingress and circuit board corrosion. H 0.47" x W 1.18"

## MOUNTING OPTIONS (SOLD SEPARATELY)

More channel options available (see page 5).

### Standard Mounting Clip

Part Number: LLI-NS3-MCL-0.8IN  
0.79" L x 0.41" H x 0.70" W

Recommended: 2 mounting clips for every 12in of Neon.

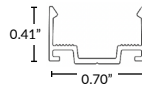

### Standard Mounting Channel

Part Number: LLI-NS3-EXT-20IN  
LLI-NS3-EXT-39IN  
19.7" or 39.4" L x 0.41" H x 0.70" W

**NOTE:** Neon sections may be mounted end-to-end on the non-power feed end to create the appearance of longer runs. End-to-end Neon sections must have a 0.5" to 1" gap to allow for expansion/contraction. A dark spot may be visible at <20ft viewing distance.

## PART NUMBER BUILDER / ORDERING GUIDE

Example part number: LLI-N4.6W-68-S3TS-R27-24V-96in

SERIES	IP RATING	TYPE	COLOR	VOLTAGE	LENGTH
LLI-N4.6W	68	S3TS	<input type="text"/>	24V	<input type="text"/>
			R27 R30 R40		Enter length in inches, up to 312"

# COLOR CHANGING RGBW LED NEON - 24V

Square Profile, 3 Illuminated Sides / Top Bending / Silicone

## ORIENTATION & MINIMUM BEND DIAMETER

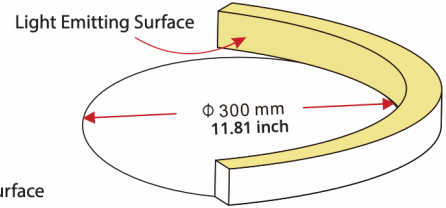
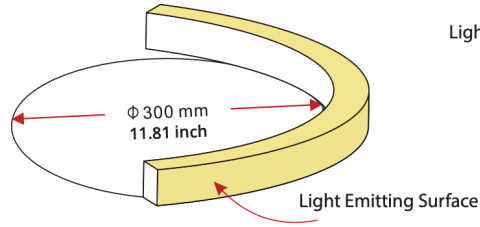
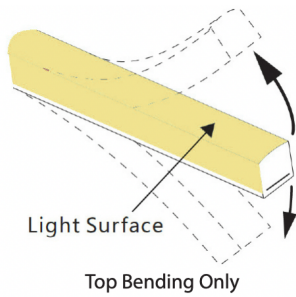

## POWER FEED ORIENTATION GUIDE

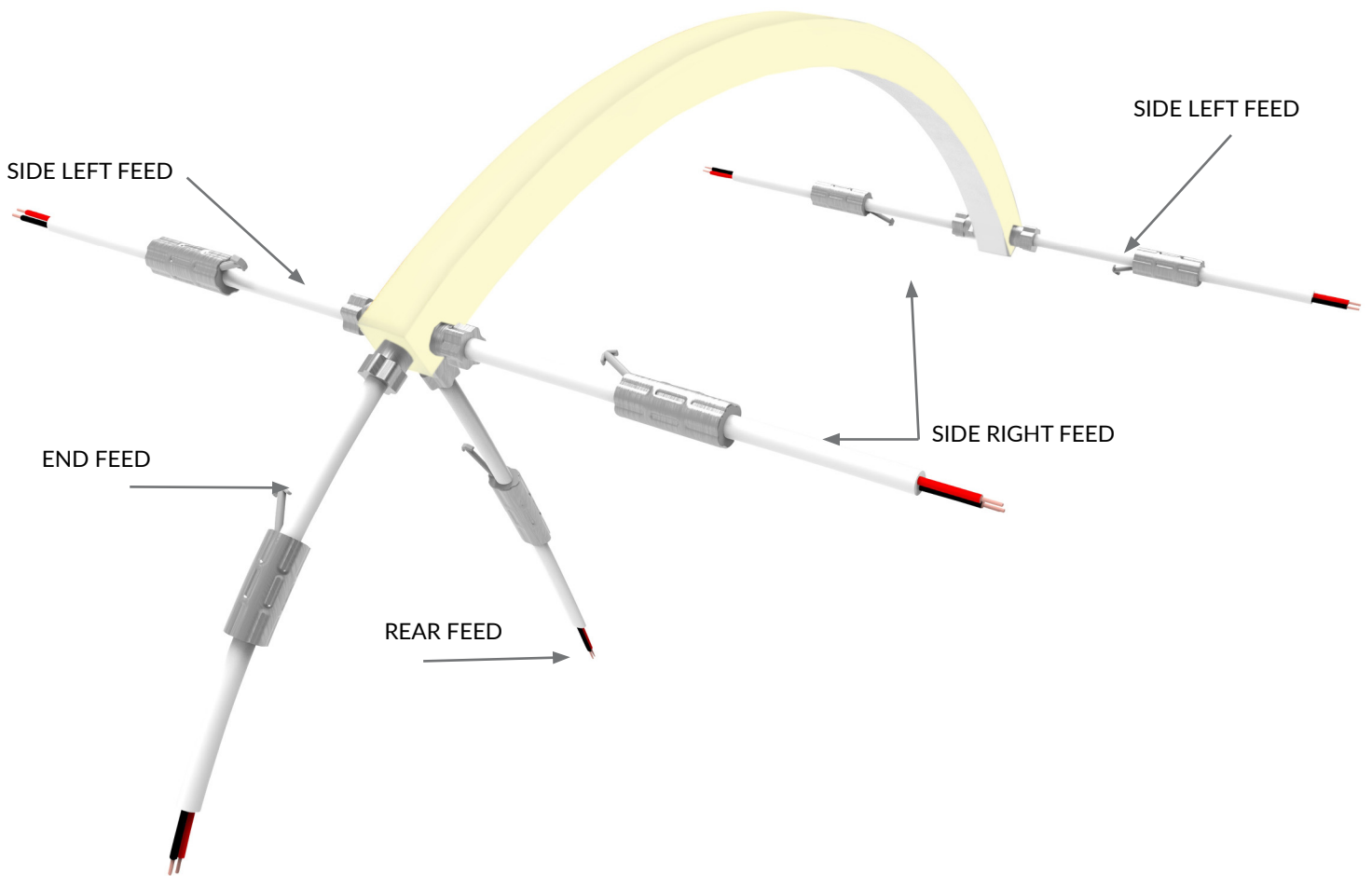

# COLOR CHANGING RGBW LED NEON - 24V

Square Profile, 3 Illuminated Sides / Top Bending / Silicone

## POWER FEED & TERMINATION OPTIONS (IP68)

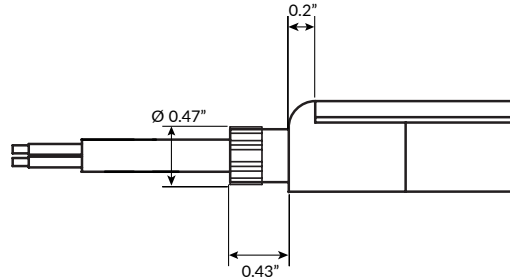
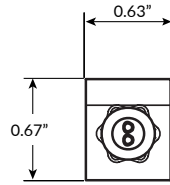
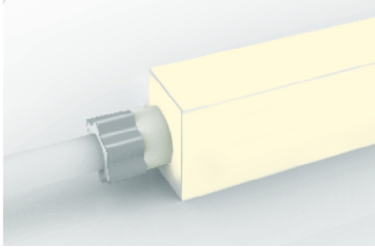

### End Power Feed

SERIES	LENGTH
LLI-NS-68-PWR5-EF	39IN 118IN 196IN 393IN

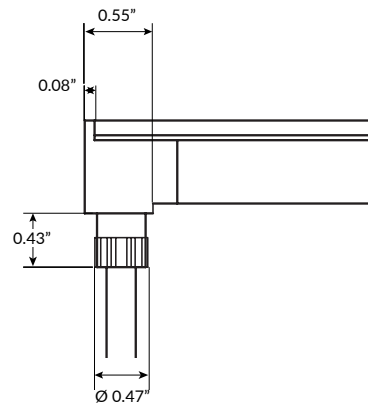
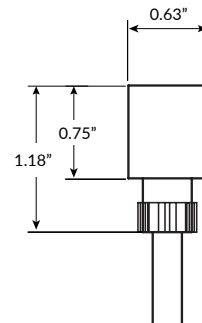

### Rear Power Feed

SERIES	LENGTH
LLI-NS-68-PWR5-RF	39IN 118IN 196IN 393IN

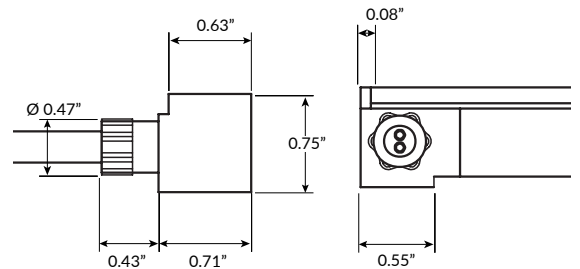
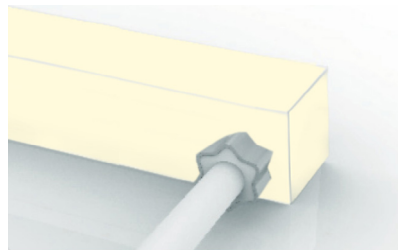
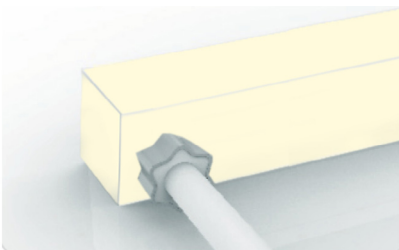

### Side Right Power Feed

SERIES	SIDE	LENGTH
LLI-NS-68-PWR5	SR	39IN 118IN 196IN 393IN

### Side Left Power Feed

SERIES	SIDE	LENGTH
LLI-NS-68-PWR5	SL	39IN 118IN 196IN 393IN

# COLOR CHANGING RGBW LED NEON - 24V

Square Profile, 3 Illuminated Sides / Top Bending / Silicone

## POWER FEED & TERMINATION OPTIONS (IP68)

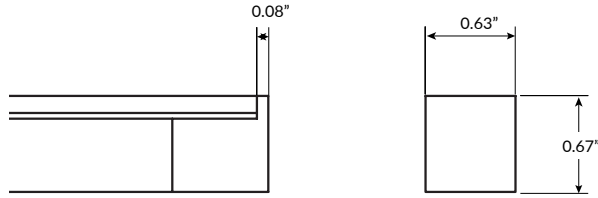
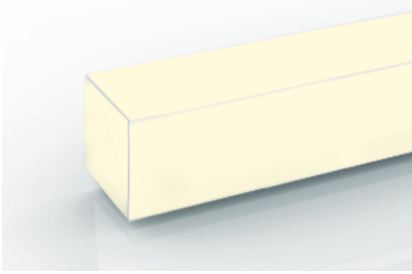

End Cap

SERIES

LLI-NS-68-EC

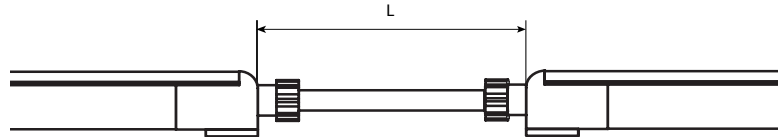
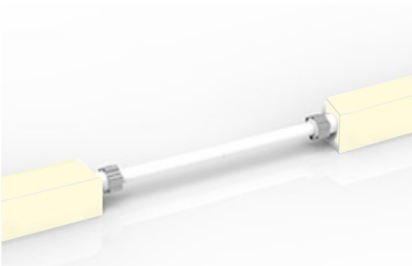

Jumper Power Connector (maximum 4 per run)

SERIES

SIDE LENGTH (L)

LLI-NS-68-CON5

SR	12IN
SL	39IN
EF	118IN
RF	196IN
	393IN

# COLOR CHANGING RGBW LED NEON - 24V

Square Profile, 3 Illuminated Sides / Top Bending / Silicone

## OVERALL LENGTH / SEGMENT POINT GUIDE

Dimension tolerance of  $\pm 1/8"$ . Measurements listed below apply to Side Feed and Rear Feed Neon only. Add 1" to measurements below for End Feed Neon. Measurements below do not include area required for routing power wire. Add 1" distance to layout to account for routing end feed power wire. This product expands and contracts in varying ambient temperatures. If butting Neon end-to-end, add 1/2" to 1" gap between sections for expansion.

10.1"	13.4"	16.7"	20.0"	23.2"	26.5"	29.8"	33.1"	36.4"	39.6"	42.9"	46.2"
49.5"	52.7"	56.0"	59.3"	62.6"	65.9"	69.1"	72.4"	75.7"	79.0"	82.3"	85.5"
88.8"	92.1"	95.4"	98.7"	101.9"	105.2"	108.5"	111.8"	115.1"	118.3"	121.6"	124.9"
128.2"	131.5"	134.7"	138.0"	141.3"	144.6"	147.9"	151.1"	154.4"	157.7"	161.0"	164.3"
167.5"	170.8"	174.1"	177.4"	180.6"	183.9"	187.2"	190.5"	193.8"	197.0"	200.3"	203.6"
206.9"	210.2"	213.4"	216.7"	220.0"	223.3"	226.6"	229.8"	233.1"	236.4"	239.7"	243.0"
246.2"	249.5"	252.8"	256.1"	259.4"	262.6"	265.9"	269.2"	272.5"	275.8"	279.0"	282.3"
285.6"	288.9"	292.2"	295.4"	298.7"	302.0"	305.3"	308.6"	311.8"	315.1"		

## MOUNTING OPTIONS

**NOTE:** Leave a 0.5" to 1" gap between Neon power feed and mounting channel, to avoid undue stress on power feed cables.

### ALUMINUM MOUNTING CHANNEL

Silver anodized finish

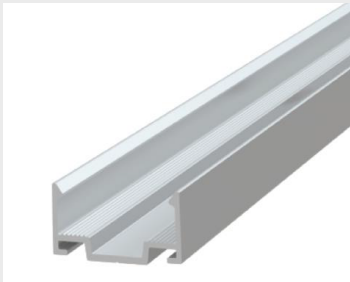

#### Mounting Clip

Recommended 2 clips every 12"

Part Number: LLI-NS3-MCL-0.8IN

Dimensions: 0.79" L x 0.41" H x 0.70" W

#### 20" Mounting Channel

Part Number: LLI-NS3-EXT-20IN

Dimensions: 19.7" L x 0.41" H x 0.70" W

#### 39" Mounting Channel

Part Number: LLI-NS3-EXT-39IN

Dimensions: 39.4" L x 0.41" H x 0.70" W

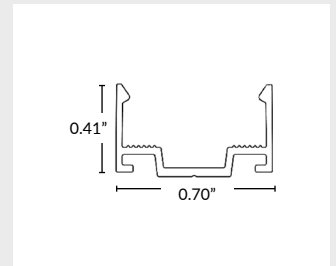

### FLEXIBLE STAINLESS STEEL MOUNTING CHANNEL

Silver anodized finish

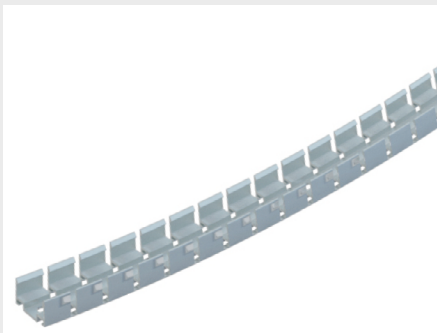

#### 20" Mounting Channel

Part Number: LLI-NS3-EXT-F-20IN

Dimensions: 20" L x 0.70" H x 0.41" W

#### 39" Mounting Channel

Part Number: LLI-NS3-EXT-F-39IN

Dimensions: 39" L x 0.70" H x 0.41" W

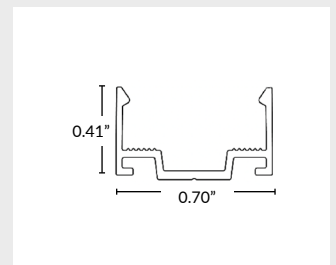

# COLOR CHANGING RGBW LED NEON - 24V

Square Profile, 3 Illuminated Sides / Top Bending / Silicone

POWER SUPPLY (SOLD SEPARATELY)

NON-DIMMABLE ELECTRONIC



PART NUMBER	CAPACITY	INPUT	OUTPUT	CLASS	LOCATION	L	W	H
LLI-PS-NDE-030W-24V-KO	30W	100-277V	24V	CLASS 2	IP66 WET	6.5"	3.5"	1.02"
LLI-PS-NDE-060W-24V-KO	60W	100-277V	24V	CLASS 2	IP66 WET	7.4"	3.5"	1.2"
LLI-PS-NDE-096W-24V-KO	96W	100-277V	24V	CLASS 2	IP66 WET	8.7"	3.7"	1.7"
LLI-PS-NDE-192W-24V-CL2-KO	2x96W	100-277V	24V	CLASS 2	IP66 WET	10.9"	4.1"	1.9"
LLI-PS-NDE-200W-24V-KO	200W	100-277V	24V	CLASS 1	IP66 WET	10.3"	4.1"	1.8"
LLI-PS-NDE-288W-24V-CL2-KO	3x96W	100-277V	24V	CLASS 2	IP66 WET	11.9"	4.1"	1.9"
LLI-PS-NDE-300W-24V-KO	300W	100-277V	24V	CLASS 1	IP66 WET	10.9"	4.3"	1.8"

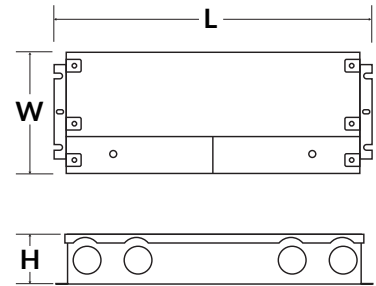

RF RECEIVER (SOLD SEPARATELY)

## LLI-C-RCV-UR-RF-4CH

CONTROLLER COMPATIBILITY	Compatible with all RF LLI-C-CTRL controllers.
LED COMPATIBILITY	Static Color, Tunable White & RGB(W) LEDs
CHANNELS	4 Channel, 8 Amp
INPUT VOLTAGE	12V / 24V (power supply not included)
CAPACITY	12V - 96W, 24V - 192W
FEATURES	Can be controlled by up to (8) controllers Can be synchronized with unlimited receivers up to 320ft away

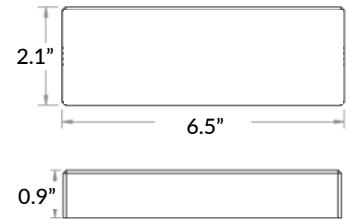

# COLOR CHANGING RGBW LED NEON - 24V

Square Profile, 3 Illuminated Sides / Top Bending / Silicone

RF CONTROLLERS (SOLD SEPARATELY)

## REMOTE CONTROLLER

### LLI-C-CTRL-RGBW-HH

RECEIVER COMPATIBILITY	Compatible with Universal RF receivers
LED COMPATIBILITY	RGB(W) LEDs
INPUT VOLTAGE	Battery operated (3 AAA batteries not included)
FEATURES	<ul style="list-style-type: none"> <li>Programmable up to 4 zones, 3 scenes</li> <li>Color adjustment</li> <li>Light intensity adjustment</li> </ul>

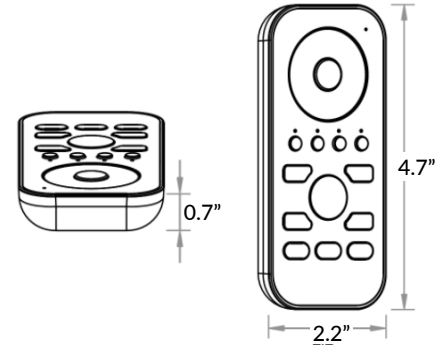

## TOUCH PANEL WALL CONTROLLER

### LLI-C-CTRL-RGBW-TP-WH

RECEIVER COMPATIBILITY	Compatible with Universal RF receivers
LED COMPATIBILITY	RGB(W) LEDs
INPUT VOLTAGE	12V DC power supply required (not included)
FEATURES	<ul style="list-style-type: none"> <li>Control range ≥ 65ft</li> <li>Programmable up to 3 scenes</li> <li>4 color presets</li> <li>Color adjustment</li> <li>Light intensity adjustment</li> </ul>

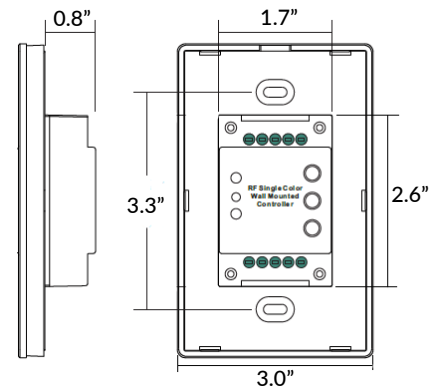
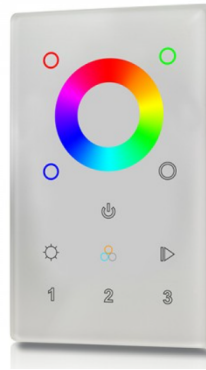

# COLOR CHANGING RGBW LED NEON - 24V

Square Profile, 3 Illuminated Sides / Top Bending / Silicone

DMX DECODERS (SOLD SEPARATELY)

## DMX512 DECODER

### LLI-C-DEC-DMX512-8A

LOCATION RATING	Indoor only
FUNCTION	Single color, variable white, RGB(W) LEDs
CHANNELS	4 channel output, 8 Amp maximum 512 addressable DMX channels
CAPACITY	12V - 96W maximum
	24V - 192W maximum
COMPATIBILITY	Compatible with LLI-C-CTRL-DMX controllers

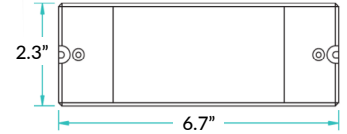

### POWER

Power supply not included. 12V/24V non-dimming power supply required.

## RDM DMX512 DECODER

### LLI-C-DEC-DMX512-8A-RDM

OUTPUT	8A maximum, 4 channels
LOCATION RATING	Indoor only
FUNCTION	RDM communication and PWM dimming for static white, static color, dynamic white, and RGB(W) LEDs
CHANNELS	4 channel output, 8 Amp maximum 512 addressable DMX channels
CAPACITY	12V - 96W maximum
	24V - 192W maximum
COMPATIBILITY	Compatible with LLI-C-CTRL-DMX controllers

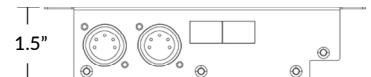
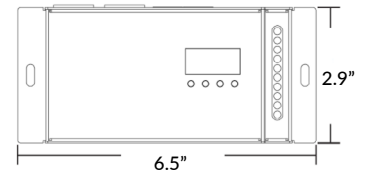

### FEATURES

Can be controlled by up to eight (8) controllers. Can be synchronized with twenty (20) decoders.

### POWER

Power supply not included. 12V/24V non-dimming power supply required.



# COLOR CHANGING RGBW LED NEON - 24V

Square Profile, 3 Illuminated Sides / Top Bending / Silicone

DMX WALL CONTROLLERS (SOLD SEPARATELY)

## STAND ALONE DMX WALL CONTROLLER, GU2

### LLI-C-CTRL-DMX-STICK-GU2

INCLUDED IN PACKAGE	Controller, CD-ROM, USB cable, connector block, power supply
OS/COMPUTER REQUIREMENTS	Mac OSx 10.6 or higher / Windows XP or higher, USB 2.0 port
PROGRAM SOFTWARE	Easy Stand Alone, ESA2 (included)
CONNECTIONS	Power (2 pins), DMX (3 pins), Port (2 pins), Micro-USB Port
MOUNTING	Single or double gang wall box
IP RATING	IP20 - dry locations only

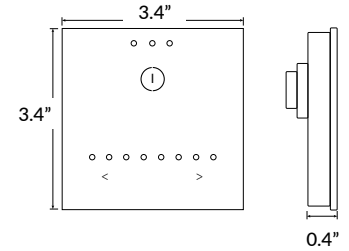

### FEATURES

- Up to 24 dynamic or static scenes
- Wall mounted control panel with glass face, touch-sensitive buttons
- Programmable with included USB cable and software – no Ethernet or WiFi required

## STAND ALONE DMX WALL CONTROLLER, DE3

### LLI-C-CTRL-DMX-STICK-DE3

INCLUDED IN PACKAGE	Controller, connector block, power supply
OS/COMPUTER REQUIREMENTS	Mac OSx 10.6 or higher / Windows XP or higher / iOS phone or tablet / Android phone or tablet
PROGRAM SOFTWARE	Easy Stand Alone, ESA2 (Mac/Windows) DMX Lightpad 3 App (iOS/Android) Easy Remote App (iOS/Android)
CONNECTIONS	Power/DMX - screw terminal and RJ45 compatible Memory - MicroSD slot Programming - MicroUSB port
POWER SUPPLY	6VDC power supply (included)
MEMORY	MicroSD card (not included)
MOUNTING	Single or double gang wall box
IP RATING	IP20 - dry locations only

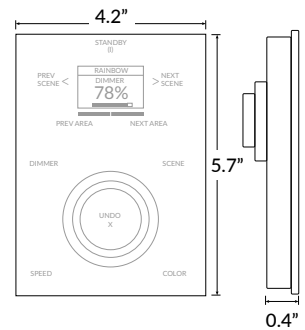
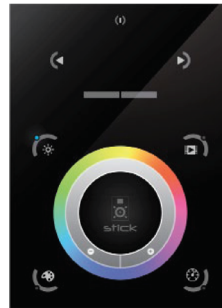

### FEATURES

- Multi-zone microSD memory
- Multi-room control with 500 scenes, 10 zones
- Integrated clock and calendar for scheduling events
- Touch-sensitive buttons
- USB and Ethernet connectivity for programming
- Windows/Mac software for programming dynamic effects
- iPhone/iPad/Android apps for remote control and program

# COLOR CHANGING RGBW LED NEON - 24V

Square Profile, 3 Illuminated Sides / Top Bending / Silicone

DMX WALL CONTROLLERS (SOLD SEPARATELY)

## STAND ALONE DMX WALL CONTROLLER, CW4

**LLI-C-CTRL-DMX-STICK-CW4** - FINISH

BL Black glass

WH White glass

INCLUDED IN PACKAGE	Controller, connector block, power supply, mini-USB cable, ESA2 software, ESA Pro2 Software
OS/COMPUTER REQUIREMENTS	Mac OSx 10.6 or higher / Windows XP or higher
PROGRAM SOFTWARE	Easy Stand Alone, ESA2 (Mac/Windows)
CONNECTIONS	Power/DMX - screw terminal and RJ45 Programming - miniUSB port
POWER SUPPLY	Requires 5-10VDC 0.6A power supply (included)
MEMORY	Integrated flash memory
MOUNTING	Single or double gang wall box
IP RATING	IP20 - dry locations only

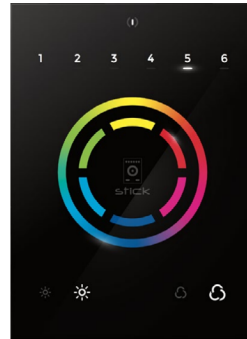

### FEATURES

- Can be controlled directly from a computer, smartphone, or tablet
- Touch-sensitive buttons, glass face
- Up to 36 dynamic or static scenes
- 8 port triggers
- 1024 DMX channels control up to 340 RGB fixtures
- Windows/Mac software for programming dynamic effects
- Internal clock and calendar with sunrise/sunset triggering

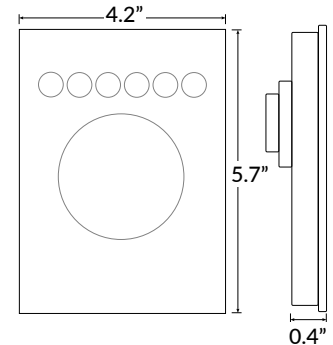

## TOUCH PANEL DMX WALL CONTROLLER

**LLI-C-CTRL-DMX-RGBW-TP**

LED TAPE COMPATIBILITY	Compatible with 12-24V DC LED tapes
PROTOCOL	DMX512
ZONES	3 zones
INTERFACE	Glass touch control
WARRANTY	5 year limited

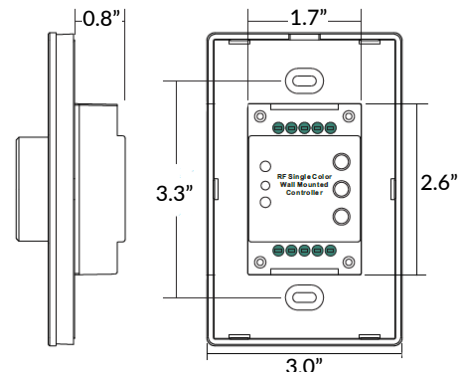
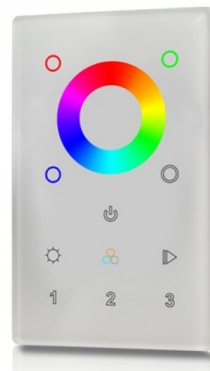

### POWER

Power supply for controller not included. 12V DC power supply required.