

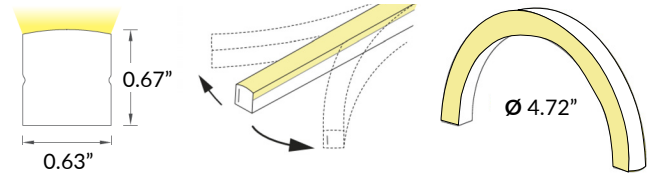

COLOR CHANGING RGB LED NEON - 24V

Square Profile / Side Bending / Silicone (SS63)

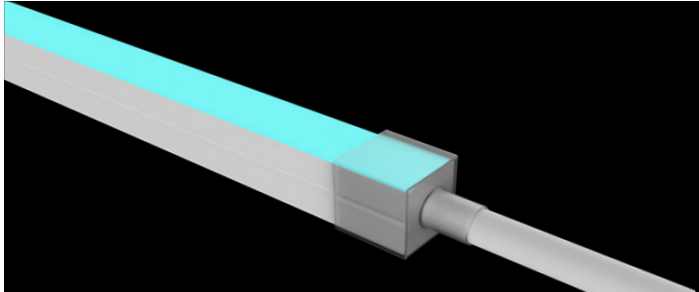

TECHNICAL INFORMATION

NOTE: All data has +/- 5% tolerance.

WATTAGE	5.3W per foot
IP RATING	IP67 - wet locations. Protected against temporary submersion, limited protection against harsh environments.
IK RATING	IK08
BEAM ANGLE	113°
HOUSING MATERIAL	Silicone
OUTPUT	RGB - 137 lm/ft Red - 27 lm/ft Green - 93 lm/ft Blue - 16 lm/ft
INPUT VOLTAGE	24VDC
SEGMENT LENGTH	Every 1.97", not field-cutttable
MAXIMUM RUN	16 feet
DIMENSIONS	0.63" W x 0.67" H
MINIMUM BEND	4.72" diameter
INSTALLATION TEMP.	32°F to 140°F (do not install when temperatures are below freezing)
OPERATING TEMP.	-4°F to 140°F
WARRANTY	3 year limited
POWER SUPPLY	Compatible with all non-dim 24VDC power supplies
CONTROLS	Color and intensity can be adjusted with DMX decoder or RF reciever and controller

ANTI-WICKING FERRULE

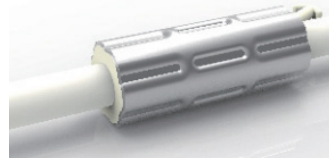

Standard on all LED Neon power cables. Located 4-6" from the connector. Protects against water ingress and circuit board corrosion. H 0.5" x W 1.25"

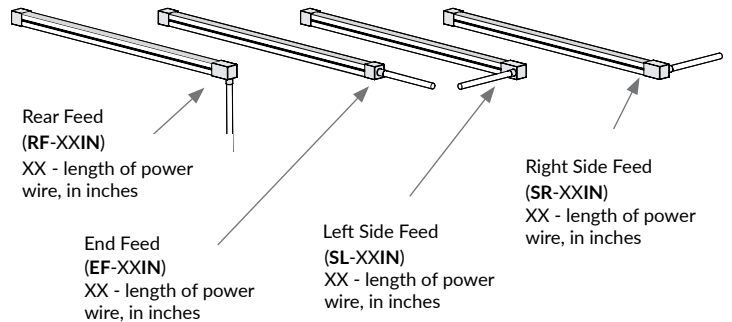

PART NUMBER BUILDER / ORDERING GUIDE

Example part number: LLI-N5.3W-67-SS63-RGB-24V-96in

SERIES	IP RATING	TYPE	COLOR	VOLTAGE	LENGTH	POWER FEED TYPE	POWER LEAD LENGTH
LLI-N5.3W	67	SS63	RGB	24V	<input type="text"/>	<input type="text"/>	<input type="text"/>

(enter length in inches, up to 192". See page 3 for available lengths)

Default: [blank] - 48" soldered lead, end feed
 EF - End Feed (enter desired lead length in inches)
 RF - Rear Feed
 SR - Right Side Feed
 SL - Left Side Feed

COLOR CHANGING RGB LED NEON - 24V

Square Profile / Side Bending / Silicone (SS63)

MOUNTING CHANNELS AND CLIPS (SOLD SEPARATELY)

NOTE: Leave a 0.5" to 1" gap between Neon power feed and mounting channel, to avoid undue stress on power feed cables.

ALUMINUM MOUNTING CHANNEL - SILVER ANODIZED



Mounting Clip
Recommended 2 clips every 12"
Part Number: LLI-NS63-MCL-1.5IN
Dimensions: 1.5" L x 0.75" H x 0.84" W



39" Mounting Channel
Part Number: LLI-NS63-EXT-39IN
Dimensions: 39" L x 0.75" H x 0.84" W

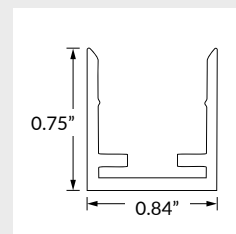

ALUMINUM MOUNTING CHANNEL WITH GRIPPER TEETH - SILVER ANODIZED

Recommended for ceilings or downward mounted Neon.



Mounting Clip
Recommended 2 clips every 12"
Part Number: LLI-NS63-MCL-G-1.5IN
Dimensions: 1.5" L x 0.75" H x 0.84" W



39" Mounting Channel
Part Number: LLI-NS63-EXT-G-39IN
Dimensions: 39" L x 0.75" H x 0.84" W

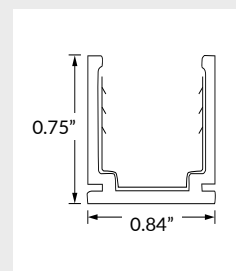

FLEXIBLE ALUMINUM MOUNTING CHANNEL - WHITE POWDER COAT



20" Mounting Channel
Part Number: LLI-NS63-EXT-F-20IN
Dimensions: 20" L x 0.71" H x 0.69" W

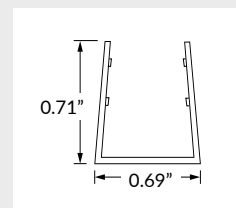

COLOR CHANGING RGB LED NEON - 24V

Square Profile / Side Bending / Silicone (SS63)

OVERALL LENGTH / SEGMENT GUIDE

Dimension tolerance of $\pm 1/8"$.

Measurements below do not include area required for routing power wire. Add 1" distance to layout to account for routing end feed power wire.

This product expands and contracts in varying ambient temperatures. If butting Neon end-to-end, add 1/2" to 1" gap between sections for expansion.

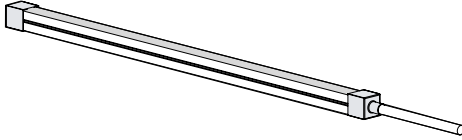

END FEED SEGMENT LENGTHS

10.5"	12.4"	14.4"	16.4"	18.3"	20.3"	22.3"	24.3"	26.2"	28.2"	30.2"	32.1"
34.1"	36.1"	38.0"	40.0"	42.0"	43.9"	45.9"	47.9"	49.8"	51.8"	53.8"	55.7"
57.7"	59.7"	61.7"	63.6"	65.6"	67.6"	69.5"	71.5"	73.5"	75.4"	77.4"	79.4"
81.3"	83.3"	85.3"	87.2"	89.2"	91.2"	93.1"	95.1"	97.1"	99.1"	101.0"	103.0"
105.0"	106.9"	108.9"	110.9"	112.8"	114.8"	116.8"	118.7"	120.7"	122.7"	124.6"	126.6"
128.6"	130.6"	132.5"	134.5"	136.5"	138.4"	140.4"	142.4"	144.3"	146.3"	148.3"	150.2"
152.2"	154.2"	156.1"	158.1"	160.1"	162.0"	164.0"	166.0"	168.0"	169.9"	171.9"	173.9"
175.8"	177.8"	179.8"	181.7"	183.7"	185.7"	187.6"	189.6"	191.6"			

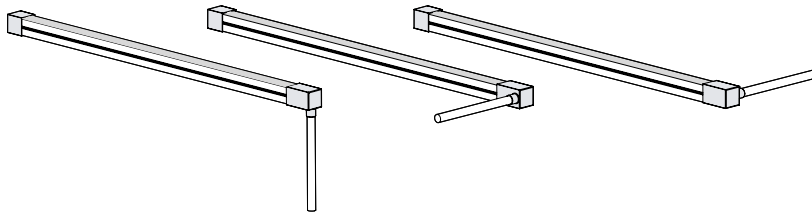

SIDE & REAR FEED SEGMENT LENGTHS

10.1"	12.1"	14.0"	16.0"	18.0"	19.9"	21.9"	23.9"	25.9"	27.8"	29.8"	31.8"
33.7"	35.7"	37.7"	39.6"	41.6"	43.6"	45.6"	47.5"	49.5"	51.5"	53.4"	55.4"
57.4"	59.3"	61.3"	63.3"	65.3"	67.2"	69.2"	71.2"	73.1"	75.1"	77.1"	79.0"
81.0"	83.0"	85.0"	86.9"	88.9"	90.9"	92.8"	94.8"	96.8"	98.7"	100.7"	102.7"
104.7"	106.6"	108.6"	110.6"	112.5"	114.5"	116.5"	118.4"	120.4"	122.4"	124.4"	126.3"
128.3"	130.3"	132.2"	134.2"	136.2"	138.1"	140.1"	142.1"	144.1"	146.0"	148.0"	150.0"
151.9"	153.9"	155.9"	157.8"	159.8"	161.8"	163.8"	165.7"	167.7"	169.7"	171.6"	173.6"
175.6"	177.5"	179.5"	181.5"	183.5"	185.4"	187.4"	189.4"	191.3"			

COLOR CHANGING RGB LED NEON - 24V

Square Profile / Side Bending / Silicone (SS63)

POWER FEED & ENDCAP DIMENSIONS

End Feed (EF)

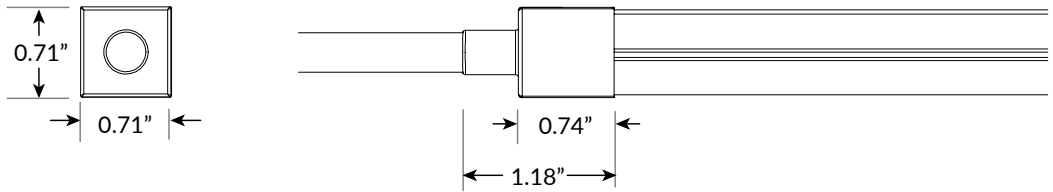

Right Side Feed (SR)

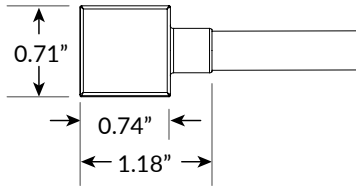

Left Side Feed (SL)

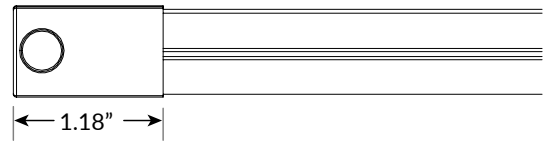

Rear Feed (RF)

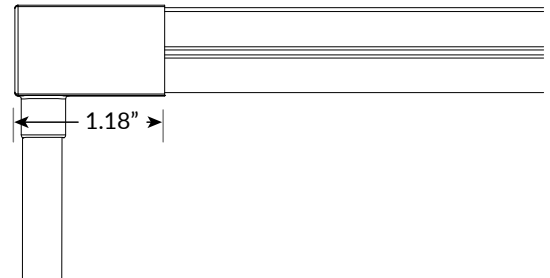
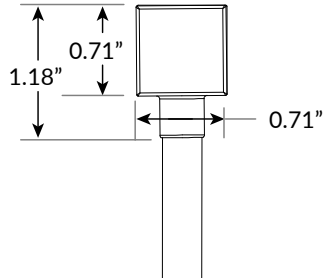

End Cap

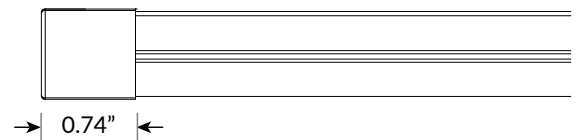
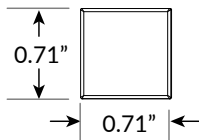

COLOR CHANGING RGB LED NEON - 24V

Square Profile / Side Bending / Silicone (SS63)

POWER SUPPLY (SOLD SEPARATELY)

NON-DIMMABLE ELECTRONIC



PART NUMBER	CAPACITY	OUTPUT	CLASS	LOCATION	L	W	H
LLI-PS-NDE-030W-24V-KO	30W	24V	CLASS 2	WET	6.5"	3.5"	1.02"
LLI-PS-NDE-060W-24V-KO	60W	24V	CLASS 2	WET	7.4"	3.5"	1.2"
LLI-PS-NDE-096W-24V-KO	96W	24V	CLASS 2	WET	8.7"	3.7"	1.7"
LLI-PS-NDE-200W-24V-KO	200W	24V	CLASS 1	WET	10.3"	4.1"	1.8"
LLI-PS-NDE-300W-24V-KO	300W	24V	CLASS 1	WET	10.9"	4.3"	1.8"

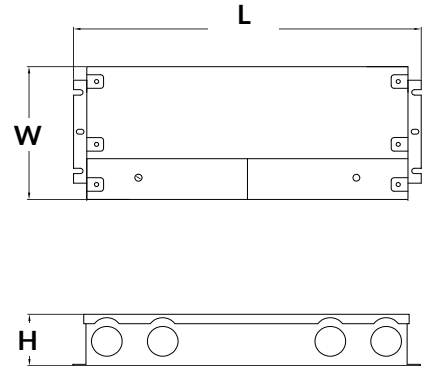

RF RECEIVER (SOLD SEPARATELY)

LLI-C-RCV-UR-RF-4CH

CONTROLLER COMPATIBILITY	Compatible with all RF LLI-C-CTRL controllers.
LED COMPATIBILITY	Static Color, Tunable White & RGB(W) LEDs
CHANNELS	4 Channel, 8 Amp
INPUT VOLTAGE	12V / 24V (power supply not included)
CAPACITY	12V - 96W, 24V - 192W
FEATURES	Can be controlled by up to (8) controllers Can be synchronized with unlimited receivers up to 320ft away

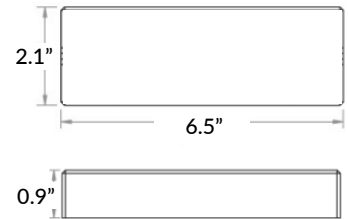

COLOR CHANGING RGB LED NEON - 24V

Square Profile / Side Bending / Silicone (SS63)

RF CONTROLLERS (SOLD SEPARATELY)

REMOTE CONTROLLER

LLI-C-CTRL-RGBW-HH

RECEIVER COMPATIBILITY	Compatible with Universal RF receivers
LED COMPATIBILITY	RGB(W) LEDs
INPUT VOLTAGE	Battery operated (3 AAA batteries not included)
FEATURES	Programmable up to 4 zones, 3 scenes Color adjustment Light intensity adjustment

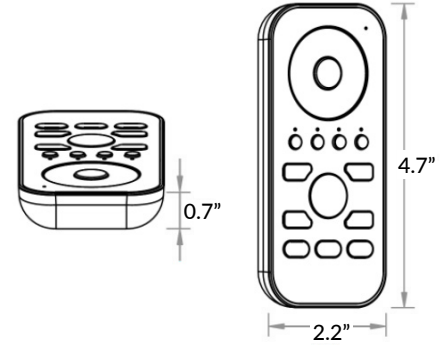

ROTARY WALL CONTROLLER

LLI-C-CTRL-RGB-RT

RECEIVER COMPATIBILITY	Compatible with Universal RF receivers
LED COMPATIBILITY	RGB LEDs
INPUT VOLTAGE	Battery operated (3V DC not included)
FEATURES	Control range ≥ 65ft Programmable single zone Color adjustment Light intensity adjustment

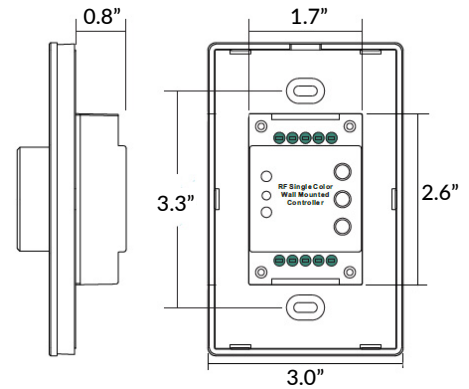

TOUCH PANEL WALL CONTROLLER

LLI-C-CTRL-RGBW-TP-WH

RECEIVER COMPATIBILITY	Compatible with Universal RF receivers
LED COMPATIBILITY	RGB(W) LEDs
INPUT VOLTAGE	12V DC power supply required (not included)
FEATURES	Control range ≥ 65ft Programmable up to 3 scenes 4 color presets Color adjustment Light intensity adjustment

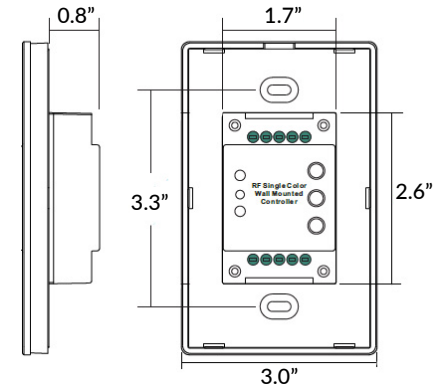

COLOR CHANGING RGB LED NEON - 24V

Square Profile / Side Bending / Silicone (SS63)

DMX DECODERS (SOLD SEPARATELY)

DMX512 DECODER

LLI-C-DEC-DMX512-8A

LOCATION RATING	Indoor only
FUNCTION	Static color, variable white, RGB(W) LEDs
CHANNELS	4 channel output, 8 Amp maximum 512 addressable DMX channels
CAPACITY	12V - 96W maximum
	24V - 192W maximum
COMPATIBILITY	Compatible with LLI-C-CTRL-DMX controllers

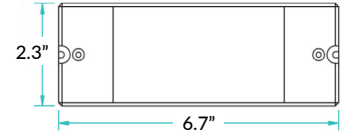

POWER

Power supply not included. 12V/24V non-dimming power supply required.

RDM DMX512 DECODER

LLI-C-DEC-DMX512-8A-RDM

OUTPUT	8A maximum, 4 channels
LOCATION RATING	Indoor only
FUNCTION	RDM communication and PWM dimming for static white, static color, tunable white, and RGB(W) LEDs
CHANNELS	4 channel output, 8 Amp maximum 512 addressable DMX channels
CAPACITY	12V - 96W maximum
	24V - 192W maximum
COMPATIBILITY	Compatible with LLI-C-CTRL-DMX controllers

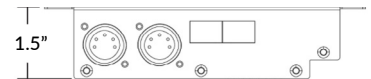
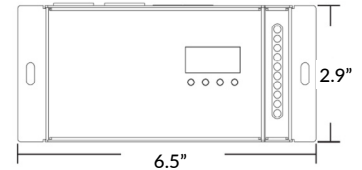

FEATURES

Can be controlled by up to eight (8) controllers. Can be synchronized with twenty (20) decoders.

POWER

Power supply not included. 12V/24V non-dimming power supply required.

COLOR CHANGING RGB LED NEON - 24V

Square Profile / Side Bending / Silicone (SS63)

DMX WALL CONTROLLERS (SOLD SEPARATELY)

STAND ALONE DMX WALL CONTROLLER, GU2

LLI-C-CTRL-DMX-STICK-GU2

INCLUDED IN PACKAGE	Controller, CD-ROM, USB cable, connector block, power supply
OS/COMPUTER REQUIREMENTS	Mac OSx 10.6 or higher / Windows XP or higher, USB 2.0 port
PROGRAM SOFTWARE	Easy Stand Alone, ESA2 (included)
CONNECTIONS	Power (2 pins), DMX (3 pins), Port (2 pins), Micro-USB Port
MOUNTING	Single or double gang wall box
IP RATING	IP20 - dry locations only

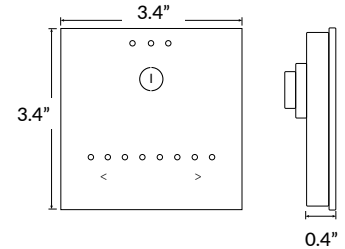

FEATURES

- Up to 24 dynamic or static scenes
- Wall mounted control panel with glass face, touch-sensitive buttons
- Programmable with included USB cable and software – no Ethernet or WiFi required

STAND ALONE DMX WALL CONTROLLER, DE3

LLI-C-CTRL-DMX-STICK-DE3

INCLUDED IN PACKAGE	Controller, connector block, power supply
OS/COMPUTER REQUIREMENTS	Mac OSx 10.6 or higher / Windows XP or higher / iOS phone or tablet / Android phone or tablet
PROGRAM SOFTWARE	Easy Stand Alone, ESA2 (Mac/Windows) DMX Lightpad 3 App (iOS/Android) Easy Remote App (iOS/Android)
CONNECTIONS	Power/DMX - screw terminal and RJ45 compatible Memory - MicroSD slot Programming - MicroUSB port
POWER SUPPLY	6VDC power supply (included)
MEMORY	MicroSD card (not included)
MOUNTING	Single or double gang wall box
IP RATING	IP20 - dry locations only

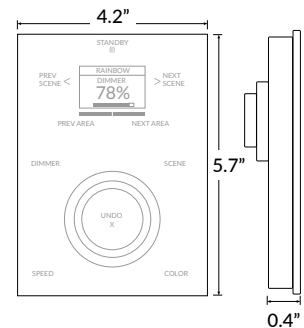
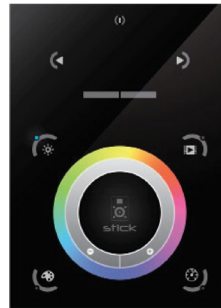

FEATURES

- Multi-zone microSD memory
- Multi-room control with 500 scenes, 10 zones
- Integrated clock and calendar for scheduling events
- Touch-sensitive buttons
- USB and Ethernet connectivity for programming
- Windows/Mac software for programming dynamic effects
- iPhone/iPad/Android apps for remote control and program

COLOR CHANGING RGB LED NEON - 24V

Square Profile / Side Bending / Silicone (SS63)

DMX WALL CONTROLLERS (SOLD SEPARATELY)

STAND ALONE DMX WALL CONTROLLER, CW4

LLI-C-CTRL-DMX-STICK-CW4 - FINISH

BL Black glass
WH White glass

INCLUDED IN PACKAGE	Controller, connector block, power supply, mini-USB cable, ESA2 software, ESA Pro2 Software
OS/COMPUTER REQUIREMENTS	Mac OSx 10.6 or higher / Windows XP or higher
PROGRAM SOFTWARE	Easy Stand Alone, ESA2 (Mac/Windows)
CONNECTIONS	Power/DMX - screw terminal and RJ45 Programming - miniUSB port
POWER SUPPLY	Requires 5-10VDC 0.6A power supply (included)
MEMORY	Integrated flash memory
MOUNTING	Single or double gang wall box
IP RATING	IP20 - dry locations only



FEATURES

- Can be controlled directly from a computer, smartphone, or tablet
- Touch-sensitive buttons, glass face
- Up to 36 dynamic or static scenes
- 8 port triggers
- 1024 DMX channels control up to 340 RGB fixtures
- Windows/Mac software for programming dynamic effects
- Internal clock and calendar with sunrise/sunset triggering

