

# COLOR CHANGING RGBW LED NEON - 24V

Square Profile / Top Bending / Silicone (ST63)

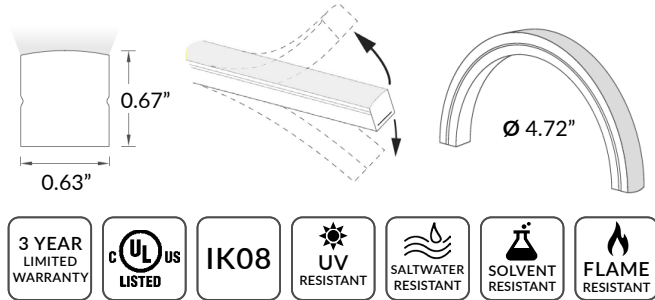
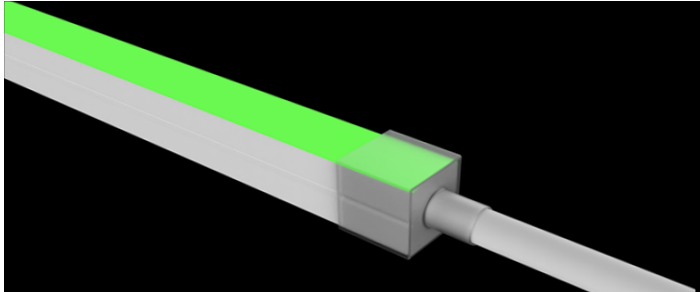

## TECHNICAL INFORMATION

NOTE: All data has +/- 5% tolerance.

|                    |  |   |
|--------------------|--|---|
| WATTAGE            | 5.3W per foot  |   |
| IP RATING          | IP67 - wet locations. Protected against temporary submersion, limited protection against harsh environments. |   |
| IK RATING          | IK08   |   |
| BEAM ANGLE         | 113°   |   |
| HOUSING MATERIAL   | Silicone, UV resistant per ISO 4892-3  |   |
| OUTPUT             | RGBW - 136 lm/ft<br>Red - 19 lm/ft<br>Green - 43 lm/ft<br>Blue - 10 lm/ft<br>3000K - 75 lm/ft                | RGBW - 148 lm/ft<br>Red - 19 lm/ft<br>Green - 43 lm/ft<br>Blue - 10 lm/ft<br>5200K - 82 lm/ft |
| CRI                | 80+  |   |
| INPUT VOLTAGE      | 24VDC  |   |
| SEGMENT LENGTH     | Every 3.28", not field-cuttable  |   |
| MAXIMUM RUN        | 16 feet  |   |
| DIMENSIONS         | 0.63" W x 0.67" H  |   |
| MINIMUM BEND       | 4.72" diameter   |   |
| INSTALLATION TEMP. | 32°F to 140°F (do not install when temperatures are below freezing)  |   |
| OPERATING TEMP.    | -4°F to 140°F  |   |
| WARRANTY           | 3 year limited   |   |
| POWER SUPPLY       | Compatible with all non-dim 24VDC power supplies   |   |
| CONTROLS           | Color and intensity can be adjusted with DMX decoder or RF receiver and controller                           |   |

### FEED TYPES

Product has 48in hard wire end feed unless otherwise specified. Other options subject to availability - contact us. Power Feed Caps and End Caps illuminate continuously to the end.

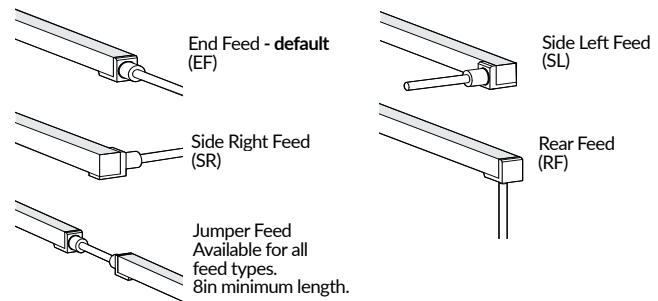

### MOUNTING

See page 3 for details. 2 clips recommended per 12in of LED Neon. Sold separately.

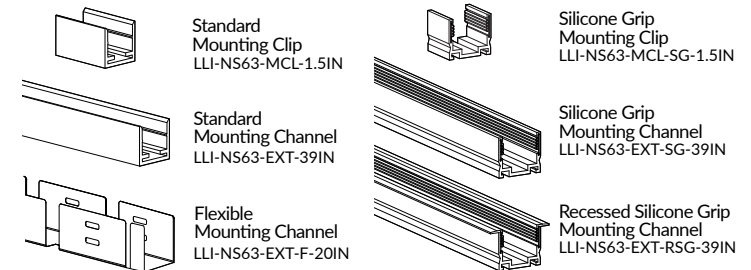

## ORDERING GUIDE

| SERIES    | IP RATING | TYPE | COLOR                | VOLTAGE | LENGTH               |
|-----------|-----------|------|----------------------|---------|----------------------|
| LLI-N5.3W | 67        | ST63 | <input type="text"/> | 24V     | <input type="text"/> |
|           |           |      | R30<br>R52           |         |                      |

Enter total length in inches. Nominal length only. Actual lengths vary by cut point. Refer to page 3.

Example part number: LLI-N5.3W-67-ST63-R30-24V-96in

Default 48in end feed power wire (PWR48EF) included. Use OPTIONAL section to specify other power feed(s).

### ← PRODUCT CODE

### OPTIONAL CODE →

| POWER FEED           |                      |                      |
|----------------------|----------------------|----------------------|
| LEAD TYPE            | LEAD LENGTH          | FEED TYPE            |
| <input type="text"/> | <input type="text"/> | <input type="text"/> |

Default [blank] - 48" hard wire end feed (PWR48EF)

**PWR** Hard Wire (no connector)    Enter desired wire length in inches    **EF** End Feed  
**RF** Rear Feed  
**SL** Side Left  
**SR** Side Right

For runs that require power feeds on both ends, repeat optional power feed code.

# COLOR CHANGING RGBW LED NEON - 24V

Square Profile / Top Bending / Silicone (ST63)

## OVERALL LENGTH / SEGMENT GUIDE

---

Dimension tolerance of  $\pm 1/8"$ .

Measurements below do not include area required for routing power wire. Add 1" distance to layout to account for routing end feed power wire.

This product expands and contracts in varying ambient temperatures. If butting Neon end-to-end, add 1/2" to 1" gap between sections for expansion.

|        |        |        |        |        |        |        |        |        |        |        |        |
|--------|--------|--------|--------|--------|--------|--------|--------|--------|--------|--------|--------|
| 10.3"  | 13.6"  | 16.9"  | 20.2"  | 23.4"  | 26.7"  | 30.0"  | 33.3"  | 36.6"  | 39.8"  | 43.1"  | 46.4"  |
| 49.7"  | 53.0"  | 56.2"  | 59.5"  | 62.8"  | 66.1"  | 69.4"  | 72.6"  | 75.9"  | 79.2"  | 82.5"  | 85.8"  |
| 89.1"  | 92.3"  | 95.6"  | 98.9"  | 102.2" | 105.5" | 108.7" | 112.0" | 115.3" | 118.6" | 121.9" | 125.1" |
| 128.4" | 131.7" | 135.0" | 138.3" | 141.5" | 144.8" | 148.1" | 151.4" | 154.7" | 157.9" | 161.2" | 164.5" |
| 167.8" | 171.1" | 174.4" | 177.6" | 180.9" | 184.2" | 187.5" | 190.8" | 194.0" |        |        |        |

# COLOR CHANGING RGBW LED NEON - 24V

Square Profile / Top Bending / Silicone (ST63)

## ANTI-WICKING FERRULE

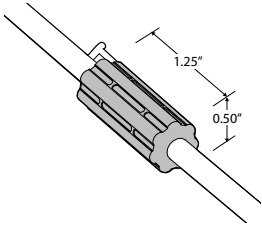

Standard on all LED Neon power feeds. Located 4-6" from the connector. Protects against water ingress and circuit board corrosion.

## MOUNTING CHANNELS AND CLIPS (SOLD SEPARATELY)

**NOTE:** Leave a 0.5" to 1" gap between Neon power feed and mounting channel, to avoid undue stress on power feed cables.

### ALUMINUM MOUNTING CHANNEL - SILVER ANODIZED

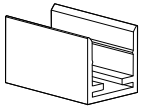

#### Mounting Clip

Recommended 2 clips every 12"

Part Number: LLI-NS63-MCL-1.5IN

Dimensions: 1.50" L x 0.75" H x 0.84" W

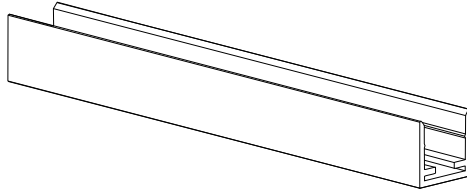

#### 39" Mounting Channel

Part Number: LLI-NS63-EXT-39IN

Dimensions: 39" L x 0.75" H x 0.84" W

### ALUMINUM MOUNTING CHANNEL WITH SILICONE GRIP - SILVER ANODIZED

Recommended for ceilings or downward mounted Neon.

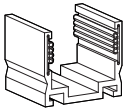

#### Silicone Grip Mounting Clip

Recommended 2 clips every 12"

Part Number: LLI-NS63-MCL-SG-1.5IN

Dimensions: 1.50" L x 0.82" H x 0.83" W

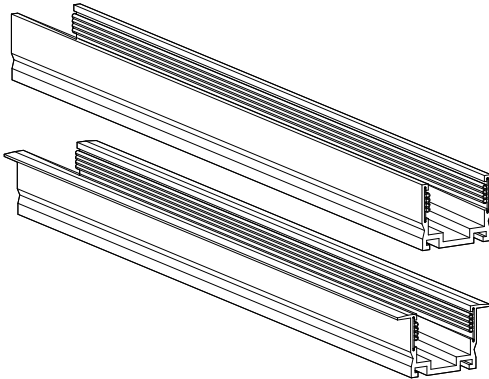

#### 39" Silicone Grip Mounting Channel

Part Number: LLI-NS63-EXT-SG-39IN

Dimensions: 39" L x 0.82" H x 0.83" W

#### 39" Recessed Silicone Grip Mounting Channel

Part Number: LLI-NS63-EXT-RSG-39IN

Dimensions: 39" L x 0.82" H x 1.20" W

### FLEXIBLE ALUMINUM MOUNTING CHANNEL - WHITE POWDER COAT

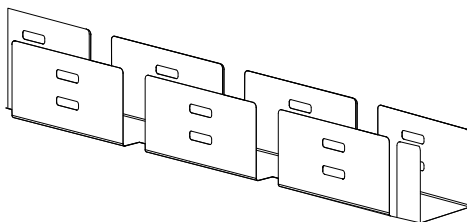

#### 20" Flexible Mounting Channel

Part Number: LLI-NS63-EXT-F-20IN

Dimensions: 20" L x 0.71" H x 0.69" W

# COLOR CHANGING RGBW LED NEON - 24V

Square Profile / Top Bending / Silicone (ST63)

POWER SUPPLY (SOLD SEPARATELY)

NON-DIMMABLE ELECTRONIC



| PART NUMBER            | CAPACITY | INPUT    | OUTPUT | CLASS   | LOCATION | L     | W    | H     |
|------------------------|----------|----------|--------|---------|----------|-------|------|-------|
| LLI-PS-NDE-030W-24V-KO | 30W      | 100-277V | 24V    | CLASS 2 | IP66 WET | 6.5"  | 3.5" | 1.02" |
| LLI-PS-NDE-060W-24V-KO | 60W      | 100-277V | 24V    | CLASS 2 | IP66 WET | 7.4"  | 3.5" | 1.2"  |
| LLI-PS-NDE-096W-24V-KO | 96W      | 100-277V | 24V    | CLASS 2 | IP66 WET | 8.7"  | 3.7" | 1.7"  |
| LLI-PS-NDE-200W-24V-KO | 200W     | 100-277V | 24V    | CLASS 1 | IP66 WET | 10.3" | 4.1" | 1.8"  |
| LLI-PS-NDE-300W-24V-KO | 300W     | 100-277V | 24V    | CLASS 1 | IP66 WET | 10.9" | 4.3" | 1.8"  |

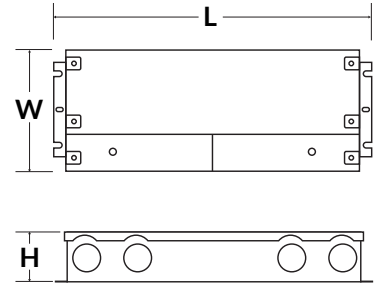

RF RECEIVER (SOLD SEPARATELY)

## LLI-C-RCV-UR-RF-4CH

|                          |   |
|--------------------------|---|
| CONTROLLER COMPATIBILITY | Compatible with all RF LLI-C-CTRL controllers.  |
| LED COMPATIBILITY        | Static Color, Tunable White & RGB(W) LEDs   |
| CHANNELS                 | 4 Channel, 8 Amp  |
| INPUT VOLTAGE            | 12V / 24V (power supply not included)   |
| CAPACITY                 | 12V - 96W, 24V - 192W   |
| FEATURES                 | Can be controlled by up to (8) controllers<br>Can be synchronized with unlimited receivers up to 320ft away |

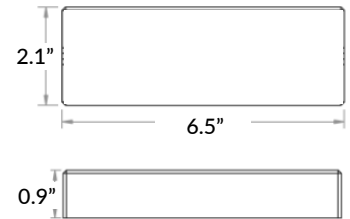

# COLOR CHANGING RGBW LED NEON - 24V

Square Profile / Top Bending / Silicone (ST63)

RF CONTROLLERS (SOLD SEPARATELY)

## REMOTE CONTROLLER

### LLI-C-CTRL-RGBW-HH

|                        |  |
|------------------------|--|
| RECEIVER COMPATIBILITY | Compatible with Universal RF receivers   |
| LED COMPATIBILITY      | RGB(W) LEDs  |
| INPUT VOLTAGE          | Battery operated (3 AAA batteries not included)  |
| FEATURES               | Programmable up to 4 zones, 3 scenes<br>Color adjustment<br>Light intensity adjustment |

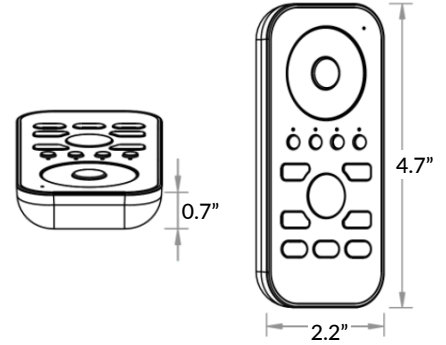

## TOUCH PANEL WALL CONTROLLER

### LLI-C-CTRL-RGBW-TP-WH

|                        |   |
|------------------------|---|
| RECEIVER COMPATIBILITY | Compatible with Universal RF receivers  |
| LED COMPATIBILITY      | RGB(W) LEDs   |
| INPUT VOLTAGE          | 12V DC power supply required (not included)   |
| FEATURES               | Control range $\geq$ 65ft<br>Programmable up to 3 scenes<br>4 color presets<br>Color adjustment<br>Light intensity adjustment |

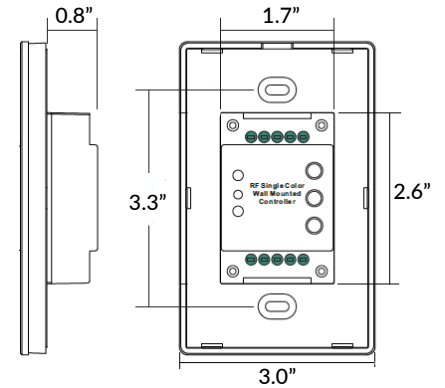
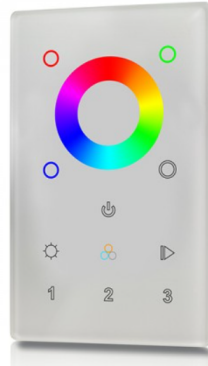

# COLOR CHANGING RGB LED NEON - 24V

Square Profile / Top Bending / Silicone (ST63)

DMX DECODERS (SOLD SEPARATELY)

## DMX512 DECODER

### LLI-C-DEC-DMX512-8A

|                 |   |
|-----------------|---|
| LOCATION RATING | Indoor only   |
| FUNCTION        | Static color, variable white, RGB(W) LEDs                       |
| CHANNELS        | 4 channel output, 8 Amp maximum<br>512 addressable DMX channels |
| CAPACITY        | 12V - 96W maximum   |
|                 | 24V - 192W maximum  |
| COMPATIBILITY   | Compatible with LLI-C-CTRL-DMX controllers                      |

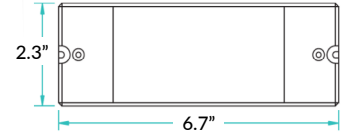

### POWER

Power supply not included. 12V/24V non-dimming power supply required.

## RDM DMX512 DECODER

### LLI-C-DEC-DMX512-8A-RDM

|                 |  |
|-----------------|--|
| OUTPUT          | 8A maximum, 4 channels   |
| LOCATION RATING | Indoor only  |
| FUNCTION        | RDM communication and PWM dimming for static white, static color, tunable white, and RGB(W) LEDs |
| CHANNELS        | 4 channel output, 8 Amp maximum<br>512 addressable DMX channels                                  |
| CAPACITY        | 12V - 96W maximum  |
|                 | 24V - 192W maximum   |
| COMPATIBILITY   | Compatible with LLI-C-CTRL-DMX controllers   |



2.9"

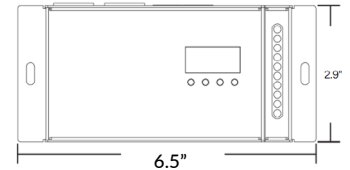

### FEATURES

Can be controlled by up to eight (8) controllers. Can be synchronized with twenty (20) decoders.

### POWER

Power supply not included. 12V/24V non-dimming power supply required.

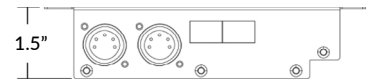

# COLOR CHANGING RGB LED NEON - 24V

Square Profile / Top Bending / Silicone (ST63)

DMX WALL CONTROLLERS (SOLD SEPARATELY)

## STAND ALONE DMX WALL CONTROLLER, GU2

### LLI-C-CTRL-DMX-STICK-GU2

|                          |  |
|--------------------------|--|
| INCLUDED IN PACKAGE      | Controller, CD-ROM, USB cable, connector block, power supply |
| OS/COMPUTER REQUIREMENTS | Mac OSx 10.6 or higher / Windows XP or higher, USB 2.0 port  |
| PROGRAM SOFTWARE         | Easy Stand Alone, ESA2 (included)                            |
| CONNECTIONS              | Power (2 pins), DMX (3 pins), Port (2 pins), Micro-USB Port  |
| MOUNTING                 | Single or double gang wall box                               |
| IP RATING                | IP20 - dry locations only                                    |

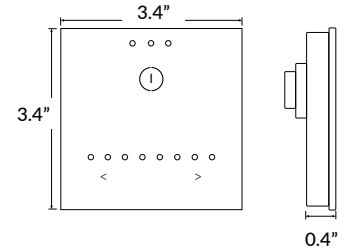

### FEATURES

- Up to 24 dynamic or static scenes
- Wall mounted control panel with glass face, touch-sensitive buttons
- Programmable with included USB cable and software – no Ethernet or WiFi required

## STAND ALONE DMX WALL CONTROLLER, DE3

### LLI-C-CTRL-DMX-STICK-DE3

|                          |   |
|--------------------------|---|
| INCLUDED IN PACKAGE      | Controller, connector block, power supply   |
| OS/COMPUTER REQUIREMENTS | Mac OSx 10.6 or higher / Windows XP or higher / iOS phone or tablet / Android phone or tablet             |
| PROGRAM SOFTWARE         | Easy Stand Alone, ESA2 (Mac/Windows)<br>DMX Lightpad 3 App (iOS/Android)<br>Easy Remote App (iOS/Android) |
| CONNECTIONS              | Power/DMX - screw terminal and RJ45 compatible<br>Memory - MicroSD slot<br>Programming - MicroUSB port    |
| POWER SUPPLY             | 6VDC power supply (included)  |
| MEMORY                   | MicroSD card (not included)   |
| MOUNTING                 | Single or double gang wall box  |
| IP RATING                | IP20 - dry locations only   |

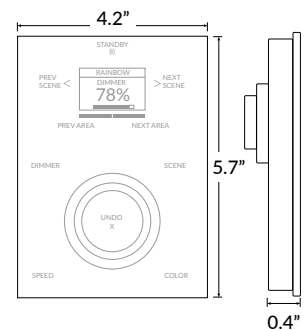
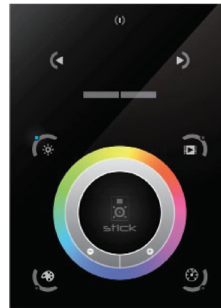

### FEATURES

- Multi-zone microSD memory
- Multi-room control with 500 scenes, 10 zones
- Integrated clock and calendar for scheduling events
- Touch-sensitive buttons
- USB and Ethernet connectivity for programming
- Windows/Mac software for programming dynamic effects
- iPhone/iPad/Android apps for remote control and program

# COLOR CHANGING RGB LED NEON - 24V

Square Profile / Top Bending / Silicone (ST63)

DMX WALL CONTROLLERS (SOLD SEPARATELY)

## STAND ALONE DMX WALL CONTROLLER, CW4

LLI-C-CTRL-DMX-STICK-CW4 - FINISH

**BL** Black glass  
**WH** White glass

|                          |   |
|--------------------------|---|
| INCLUDED IN PACKAGE      | Controller, connector block, power supply, mini-USB cable, ESA2 software, ESA Pro2 Software |
| OS/COMPUTER REQUIREMENTS | Mac OSx 10.6 or higher / Windows XP or higher   |
| PROGRAM SOFTWARE         | Easy Stand Alone, ESA2 (Mac/Windows)  |
| CONNECTIONS              | Power/DMX - screw terminal and RJ45<br>Programming - miniUSB port                           |
| POWER SUPPLY             | Requires 5-10VDC 0.6A power supply (included)   |
| MEMORY                   | Integrated flash memory   |
| MOUNTING                 | Single or double gang wall box  |
| IP RATING                | IP20 - dry locations only   |

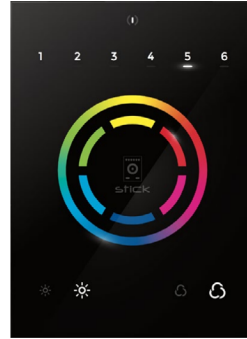

### FEATURES

- Can be controlled directly from a computer, smartphone, or tablet
- Touch-sensitive buttons, glass face
- Up to 36 dynamic or static scenes
- 8 port triggers
- 1024 DMX channels control up to 340 RGB fixtures
- Windows/Mac software for programming dynamic effects
- Internal clock and calendar with sunrise/sunset triggering

