

STATIC WHITE LED NEON - HIGH TEMP. - 24V

Square Profile / Top Bending / Silicone

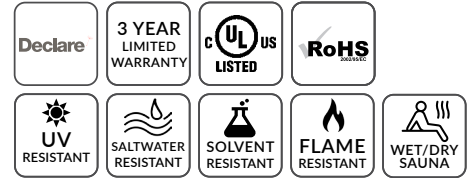
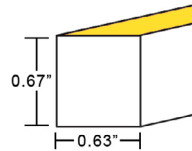
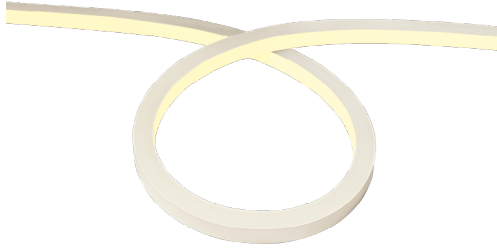

TECHNICAL INFORMATION

NOTE: All data has +/- 5% tolerance.

WATTAGE	1.9W per foot
IP RATING	IP68 - wet locations. Protected against temporary submersion, limited protection against harsh environments.
APPLICATION	Designed specifically for use in high ambient temperature applications such as wet or dry saunas.
PROFILE	Square
BEND ORIENTATION	Top Bending
HOUSING MATERIAL	Silicone, UV resistant per ISO 4892-3
OUTPUT	2200K - 69 lm/ft 2700K - 85 lm/ft 3000K - 85 lm/ft 3500K - 88 lm/ft 4000K - 88 lm/ft 5700K - 88 lm/ft
CRI	80+
INPUT VOLTAGE	24VDC
SEGMENT LENGTH	Every 2.2", not field-cuttable
MAXIMUM RUN	32 feet
DIMENSIONS	0.63" W x 0.67" H (16mm x 17mm)
MINIMUM BEND	12" diameter
INSTALLATION TEMP.	-40°F to 122°F
OPERATING TEMP.	-40°F to 194°F
WARRANTY	3 year limited
POWER SUPPLY	Compatible with all dimmable 24VDC power supplies - see power supply section of website. Consult power supply specification sheet for max. operating temperature before locating power supply.

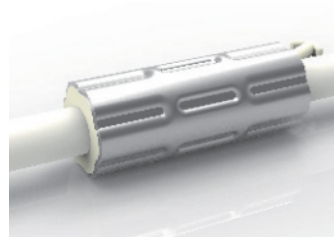

ANTI-WICKING FERRULE

Standard on all LED Neon power cables. Located 4.5" from the connector. Protects against water ingress and circuit board corrosion. H 0.47" x W 1.18"

MOUNTING OPTIONS (SOLD SEPARATELY)

More clips and channel options available (see page 5-7).

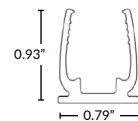

Anti-Corrosion Reinforced Plastic Mounting Clip

Recommended for high humidity applications
Part Number: LLI-NS-MCL-CP-1.4IN
Dimensions: 1.4" L x 0.93" H x 0.79" W

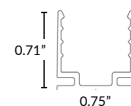

Aluminum Mounting Clip

Part Number: LLI-NS-MCL-1.4IN
1.38" L x 0.71" H x 0.75" W

NOTE: Neon sections may be mounted end-to-end on the non-power feed end to create the appearance of longer runs. End-to-end Neon sections must have a 0.5" to 1" gap to allow for expansion/contraction. A dark spot may be visible at <20ft viewing distance.

PART NUMBER BUILDER / ORDERING GUIDE

Example part number: LLI-NH1.9W-68-ST5-30K-24V-96in

SERIES	IP RATING	TYPE	CCT	VOLTAGE	LENGTH
LLI-NH1.9W	68	ST5		24V	
			22K - 69 lm/ft		(enter length in inches, up to 384")
			27K - 85 lm/ft		
			30K - 85 lm/ft		
			35K - 88 lm/ft		
			40K - 88 lm/ft		
			57K - 88 lm/ft		

STATIC WHITE LED NEON - HIGH TEMP. - 24V

Square Profile / Top Bending / Silicone

ORIENTATION & MINIMUM BEND DIAMETER

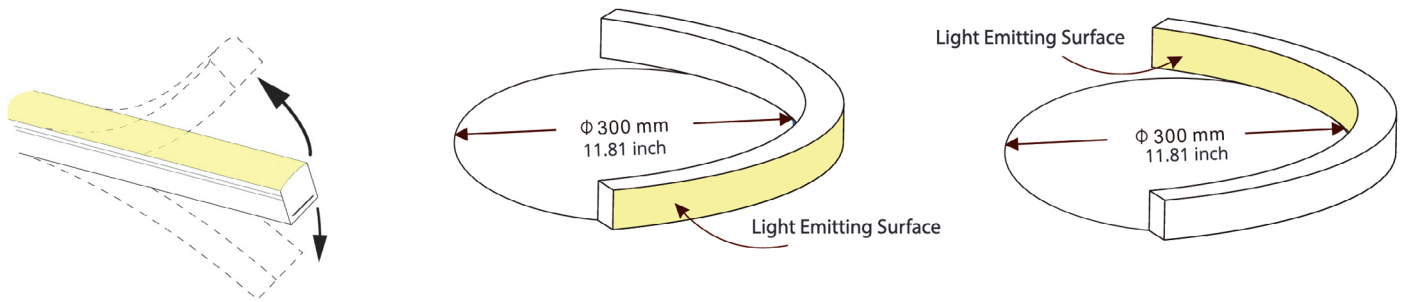

POWER FEED ORIENTATION GUIDE

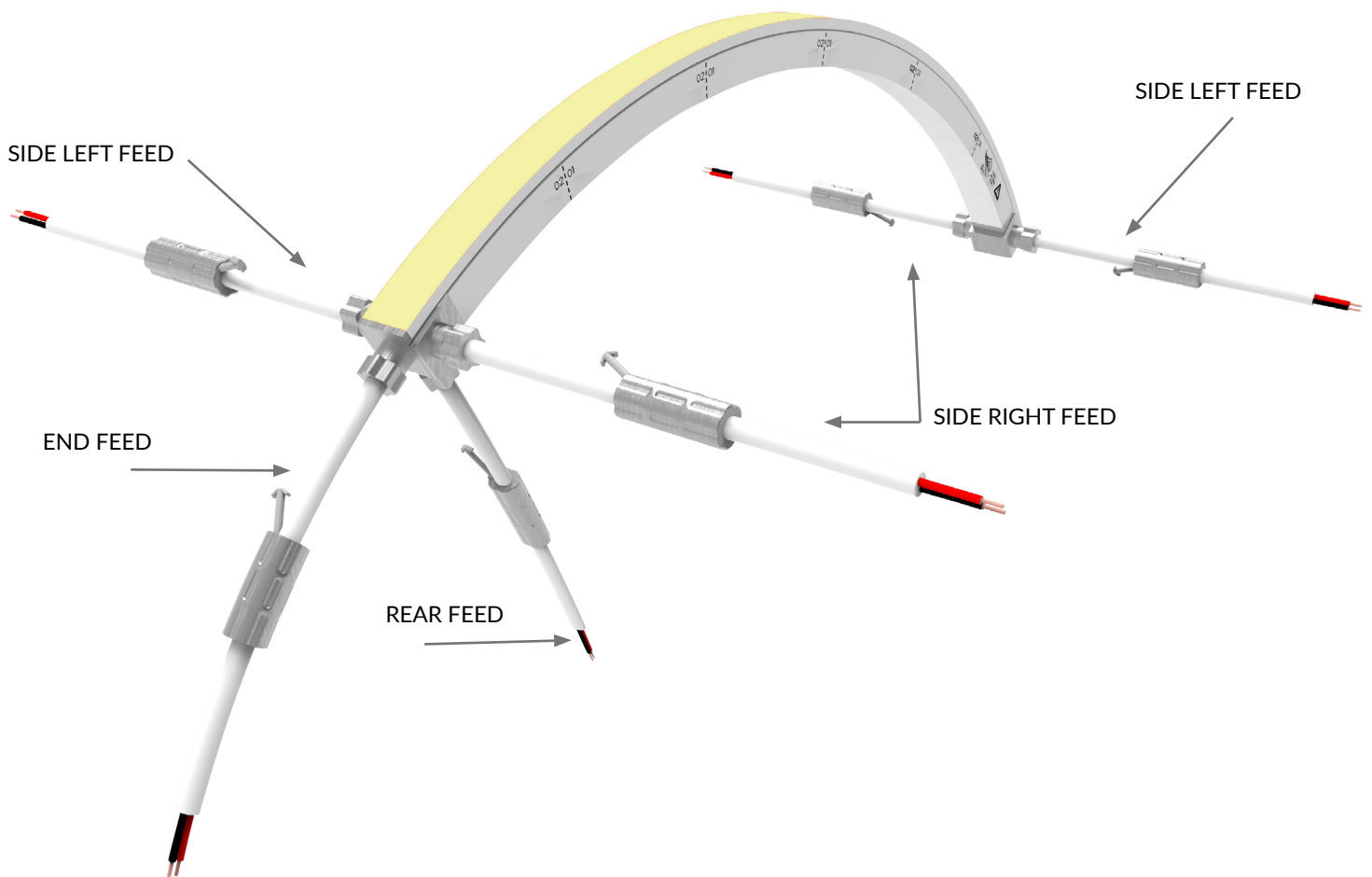

STATIC WHITE LED NEON - HIGH TEMP. - 24V

Square Profile / Top Bending / Silicone

POWER FEED & TERMINATION OPTIONS (IP68)

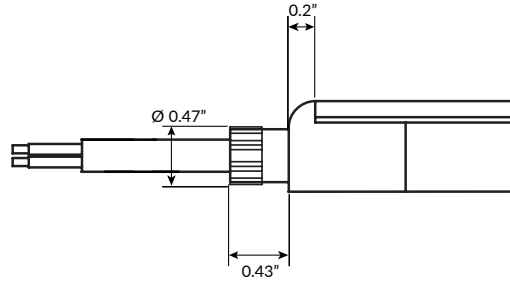
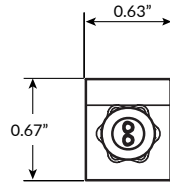
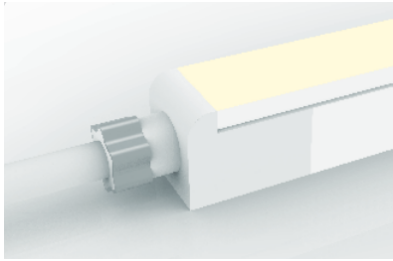

End Power Feed

SERIES	LENGTH
LLI-NS-68-PWR2-EF	39IN 118IN 196IN 393IN

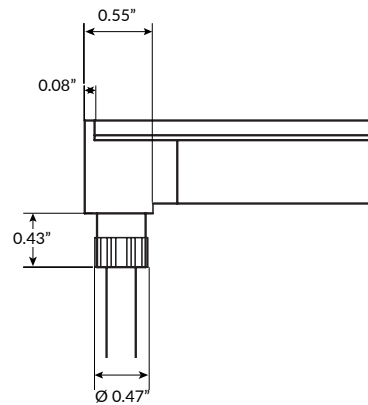
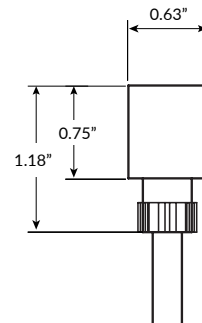

Rear Power Feed

SERIES	LENGTH
LLI-NS-68-PWR2-RF	39IN 118IN 196IN 393IN

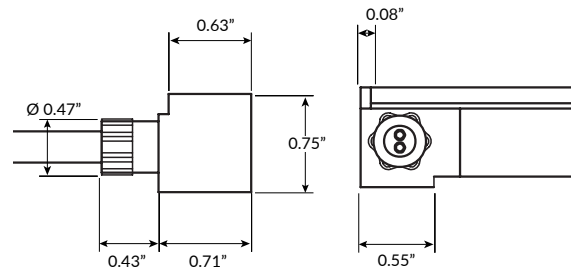
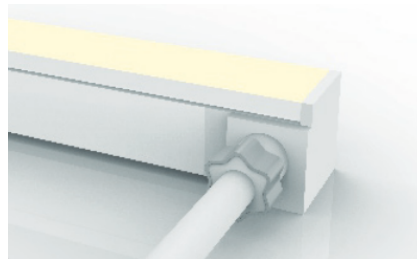
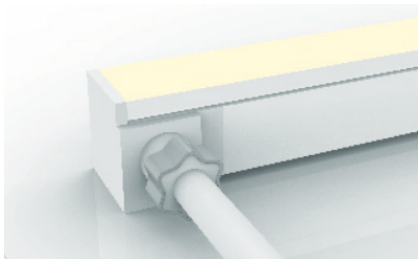

Side Right Power Feed

SERIES	SIDE	LENGTH
LLI-NS-68-PWR2	SR	39IN 118IN 196IN 393IN

Side Left Power Feed

SERIES	SIDE	LENGTH
LLI-NS-68-PWR2	SL	39IN 118IN 196IN 393IN

STATIC WHITE LED NEON - HIGH TEMP. - 24V

Square Profile / Top Bending / Silicone

POWER FEED & TERMINATION OPTIONS (IP68)

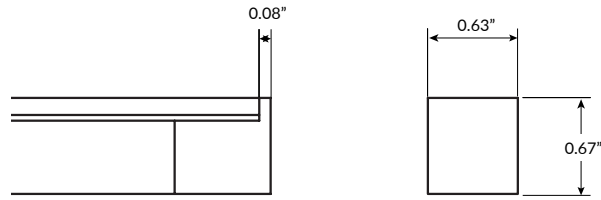
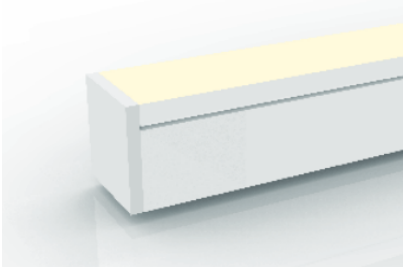

End Cap

SERIES

LLI-NS-68-EC



Jumper Power Connector (maximum 4 per run)

SERIES

SIDE

LENGTH (L)

LLI-NS-68-CON2

SR	12IN
SL	39IN
EF	118IN
RF	196IN
	393IN

STATIC WHITE LED NEON - HIGH TEMP. - 24V

Square Profile / Top Bending / Silicone

OVERALL LENGTH / SEGMENT POINT GUIDE

Dimension tolerance of $\pm 1/8"$. Measurements listed below apply to Side Feed and Rear Feed Neon only. Add 1" to measurements below for End Feed Neon. Measurements below do not include area required for routing power wire. Add 1" distance to layout to account for routing end feed power wire. This product expands and contracts in varying ambient temperatures. If butting Neon end-to-end, add 1/2" to 1" gap between sections for expansion.

11.2"	13.4"	15.6"	17.8"	20.0"	22.2"	24.4"	26.5"	28.7"	30.9"	33.1"	35.3"
37.5"	39.7"	41.9"	44.1"	46.2"	48.4"	50.6"	52.8"	55.0"	57.2"	59.4"	61.6"
63.8"	65.9"	68.1"	70.3"	72.5"	74.7"	76.9"	79.1"	81.3"	83.5"	85.6"	87.8"
90.0"	92.2"	94.4"	96.6"	98.8"	101.0"	103.2"	105.3"	107.5"	109.7"	111.9"	114.1"
116.3"	118.5"	120.7"	122.9"	125.0"	127.2"	129.4"	131.6"	133.8"	136.0"	138.2"	140.4"
142.6"	144.7"	146.9"	149.1"	151.3"	153.5"	155.7"	157.9"	160.1"	162.3"	164.4"	166.6"
168.8"	171.0"	173.2"	175.4"	177.6"	179.8"	182.0"	184.1"	186.3"	188.5"	190.7"	192.9"
195.1"	197.3"	199.5"	201.7"	203.9"	206.0"	208.2"	210.4"	212.6"	214.8"	217.0"	219.2"
221.4"	223.6"	225.7"	227.9"	230.1"	232.3"	234.5"	236.7"	238.9"	241.1"	243.3"	245.4"
247.6"	249.8"	252.0"	254.2"	256.4"	258.6"	260.8"	263.0"	265.1"	267.3"	269.5"	271.7"
273.9"	276.1"	278.3"	280.5"	282.7"	284.8"	287.0"	289.2"	291.4"	293.6"	295.8"	298.0"
300.2"	302.4"	304.5"	306.7"	308.9"	311.1"	313.3"	315.5"	317.7"	319.9"	322.1"	324.2"
326.4"	328.6"	330.8"	333.0"	335.2"	337.4"	339.6"	341.8"	343.9"	346.1"	348.3"	350.5"
352.7"	354.9"	357.1"	359.3"	361.5"	363.6"	365.8"	368.0"	370.2"	372.4"	374.6"	376.8"
379.0"	381.2"	383.3"									

MOUNTING OPTIONS

NOTE: Leave a 0.5" to 1" gap between Neon power feed and mounting channel, to avoid undue stress on power feed cables.

ANTI-CORROSION REINFORCED PLASTIC MOUNTING CHANNEL

Recommended for high humidity applications
Clear plastic



Mounting Clip

Recommended 2 clips every 12"

Part Number: LLI-NS-MCL-CP-1.4IN

Dimensions: 1.38" L x 0.93" H x 0.79" W

20" Mounting Channel

Part Number: LLI-NS-EXT-CP-20IN

Dimensions: 20" L x 0.93" H x 0.79" W

39" Mounting Channel

Part Number: LLI-NS-EXT-CP-39IN

Dimensions: 39.4" L x 0.93" H x 0.79" W

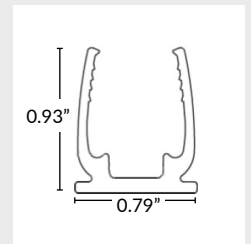

ALUMINUM MOUNTING CHANNEL

Silver anodized finish



Mounting Clip

Recommended 2 clips every 12"

Part Number: LLI-NS-MCL-1.4IN

Dimensions: 1.38" L x 0.71" H x 0.75" W

20" Mounting Channel

Part Number: LLI-NS-EXT-20IN

Dimensions: 20" L x 0.71" H x 0.75" W

39" Mounting Channel

Part Number: LLI-NS-EXT-39IN

Dimensions: 39" L x 0.71" H x 0.75" W

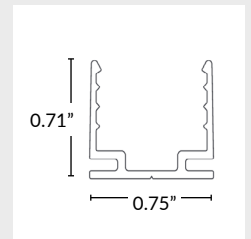

STATIC WHITE LED NEON - HIGH TEMP. - 24V

Square Profile / Top Bending / Silicone

MOUNTING OPTIONS

NOTE: Leave a 0.5" to 1" gap between Neon power feed and mounting channel, to avoid undue stress on power feed cables.

PLASTIC MOUNTING CHANNEL

White finish

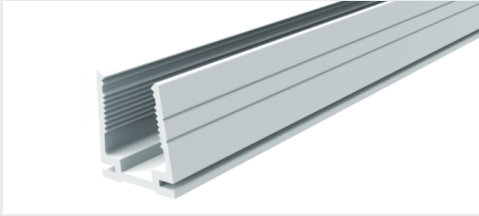

20" Mounting Channel

Part Number: LLI-NS-EXT-P-20IN
Dimensions: 20" L x 0.83" H x 0.74" W

39" Mounting Channel

Part Number: LLI-NS-EXT-P-39IN
Dimensions: 39.4" L x 0.83" H x 0.74" W

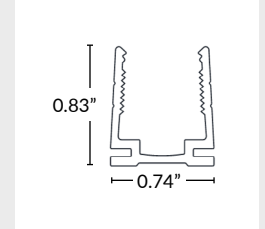

SILICONE GRIP ALUMINUM MOUNTING CHANNEL

Recommended for ceiling and wall applications
Silver anodized finish

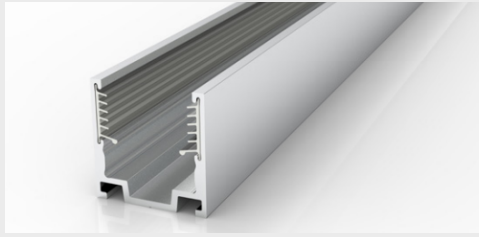

Mounting Clip

Recommended 2 clips every 12"
Part Number: LLI-NS-MCL-SG-0.8IN
Dimensions: 0.8" L x 0.82" H x 0.8" W

20" Mounting Channel

Part Number: LLI-NS-EXT-SG-20IN
Dimensions: 20" L x 0.82" H x 0.8" W

39" Mounting Channel

Part Number: LLI-NS-EXT-SG-39IN
Dimensions: 39.4" L x 0.82" H x 0.8" W

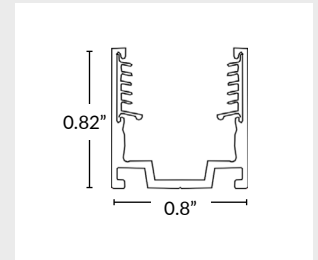

ALUMINUM RACEWAY CHANNEL WITH SILICONE GRIP

Silver anodized finish

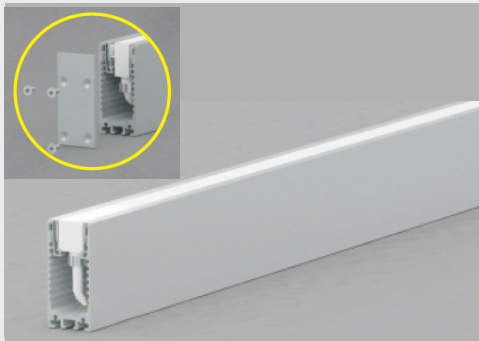

Two (2) endcaps and screws included.
Joiner bars available (sold separately).

20" Mounting Channel

Part Number: LLI-NS-EXT-RCW-SG-20IN
Dimensions: 20" L x 2.44" H x 1.14" W

39" Mounting Channel

Part Number: LLI-NS-EXT-RCW-SG-39IN
Dimensions: 39.4" L x 2.44" H x 1.14" W

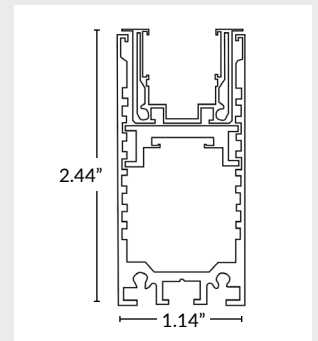

RECESSED MOUNTING CHANNEL

Silver anodized finish

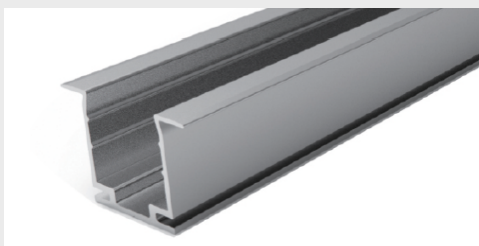

Mounting Clip

Recommended 2 clips every 12"
Part Number: LLI-NS-MCL-R-1.4IN
Dimensions: 1.38" L x 0.83" H x 1.1" W

20" Mounting Channel

Part Number: LLI-NS-EXT-R-20IN
Dimensions: 20" L x 0.83" H x 1.1" W

39" Mounting Channel

Part Number: LLI-NS-EXT-R-39IN
Dimensions: 39.4" L x 0.83" H x 1.1" W

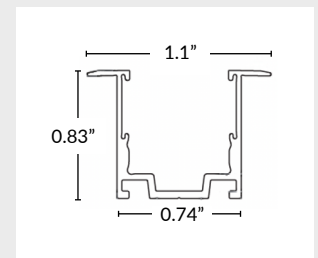

STATIC WHITE LED NEON - HIGH TEMP. - 24V

Square Profile / Top Bending / Silicone

MOUNTING CHANNELS (CONTINUED)

NOTE: Leave a 0.5" to 1" gap between Neon power feed and mounting channel, to avoid undue stress on power feed cables.

SILICONE GRIP RECESSED CHANNEL

Recommended for ceiling and wall applications
Silver anodized finish



Mounting Clip

Recommended 2 clips every 12"

Part Number: LLI-NS-MCL-RSG-0.8IN
Dimensions: 0.8" L x 0.82" H x 1.18" W

20" Mounting Channel

Part Number: LLI-NS-EXT-RSG-20IN
Dimensions: 20" L x 0.82" H x 1.18" W

39" Mounting Channel

Part Number: LLI-NS-EXT-RSG-39IN
Dimensions: 39.4" L x 0.82" H x 1.18" W

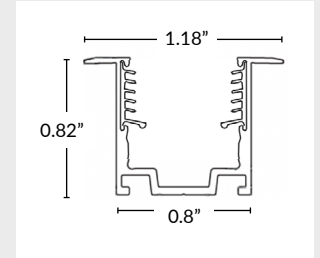

FLEXIBLE SILICONE GRIP ALUMINUM MOUNTING CHANNEL

Silver anodized finish

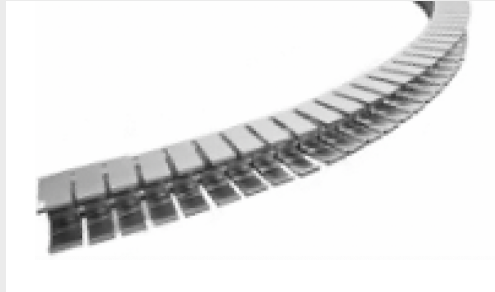

39" Mounting Channel

Part Number: LLI-NS-EXT-FSG-TB-39IN
Dimensions: 39" L x 0.82" H x 0.80" W

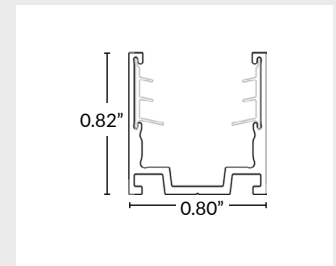

ADJUSTABLE MOUNTING BRACKET

Recommended 3 brackets for every 39" channel
Adjusts in 15° increments, notches every 30°



Part Number: LLI-NS-BKT-ADJ
Dimensions: 1" L x 1.6" H x 1.8" W

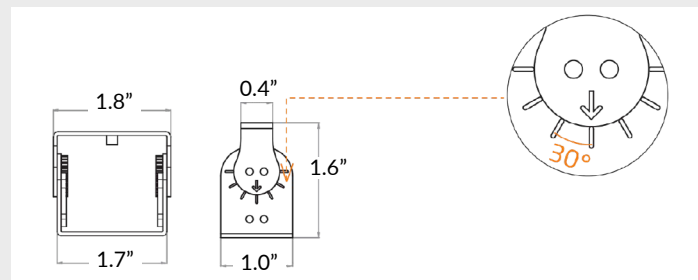

SIDE MOUNTING BRACKET

Recommended 2 brackets for every 20" or 39" channel
Not compatible with mounting clips



Part Number: LLI-NS-BKT-90D
Dimensions: 0.8" L x 2.8" H x 1.0" W

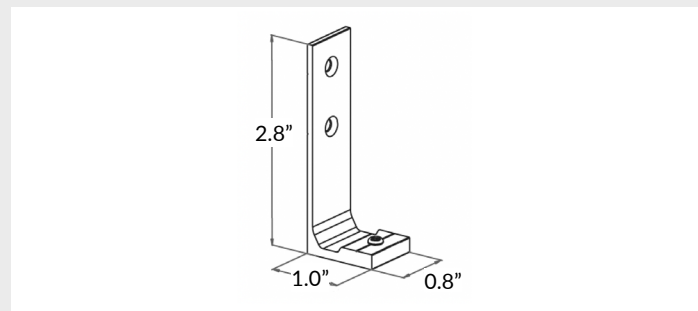

DIMMABLE ELECTRONIC 0-10V 

Optimal performance dims to 0%.*

PART NUMBER	CAPACITY	INPUT	OUTPUT	CLASS	LOCATION	L	W	H
LLI-PS-DE010-030W-24V-KO	30W	120V or 277V	24V	CLASS 2	IP66 WET	6.5"	3.6"	1.6"
LLI-PS-DE010-060W-24V-KO	60W	120V or 277V	24V	CLASS 2	IP66 WET	7.4"	3.6"	1.6"
LLI-PS-DE010-096W-24V-KO	96W	120V or 277V	24V	CLASS 2	IP66 WET	8.7"	3.7"	1.7"
LLI-PS-DE010-192W-24V-CL2-KO	2x96W	120V or 277V	24V	CLASS 2	IP66 WET	10.9"	4.3"	1.9"
LLI-PS-DE010-200W-24V-KO	200W	120V or 277V	24V	CLASS 1	IP66 WET	10.2"	4.1"	1.8"
LLI-PS-DE010-288W-24V-CL2-KO	3x96W	120V or 277V	24V	CLASS 2	IP66 WET	11.9"	4.3"	1.9"
LLI-PS-DE010-300W-24V-KO	300W	120V or 277V	24V	CLASS 1	IP66 WET	10.9"	4.3"	1.8"

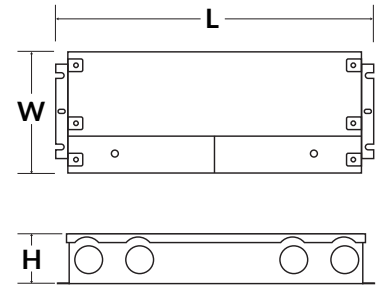

NON-DIMMABLE ELECTRONIC 

PART NUMBER	CAPACITY	INPUT	OUTPUT	CLASS	LOCATION	L	W	H
LLI-PS-NDE-030W-24V-KO	30W	100-277V	24V	CLASS 2	IP66 WET	6.5"	3.5"	1.02"
LLI-PS-NDE-060W-24V-KO	60W	100-277V	24V	CLASS 2	IP66 WET	7.4"	3.5"	1.2"
LLI-PS-NDE-096W-24V-KO	96W	100-277V	24V	CLASS 2	IP66 WET	8.7"	3.7"	1.7"
LLI-PS-NDE-192W-24V-CL2-KO	2x96W	100-277V	24V	CLASS 2	IP66 WET	10.9"	4.1"	1.9"
LLI-PS-NDE-200W-24V-KO	200W	100-277V	24V	CLASS 1	IP66 WET	10.3"	4.1"	1.8"
LLI-PS-NDE-288W-24V-CL2-KO	3x96W	100-277V	24V	CLASS 2	IP66 WET	11.9"	4.1"	1.9"
LLI-PS-NDE-300W-24V-KO	300W	100-277V	24V	CLASS 1	IP66 WET	10.9"	4.3"	1.8"

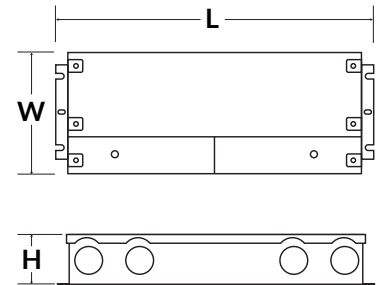

UNIVERSAL DIMMABLE ELECTRONIC FLICKER-FREE 

Optimal performance dims to 0-2%.

PART NUMBER	CAPACITY	INPUT	OUTPUT	CLASS	LOCATION	L	W	H
LLI-PS-UDIMM-030W-24V-KO	30W	110-277V	24V	CLASS 2	IP66 WET	6.5"	3.7"	1.6"
LLI-PS-UDIMM-060W-24V-KO	60W	110-277V	24V	CLASS 2	IP66 WET	7.4"	3.7"	1.6"
LLI-PS-UDIMM-096W-24V-KO	96W	110-277V	24V	CLASS 2	IP66 WET	8.7"	3.7"	1.6"
LLI-PS-UDIMM-192W-24V-CL2-KO	2x96W	110-277V	24V	CLASS 2	IP66 WET	10.9"	4.3"	1.8"
LLI-PS-UDIMM-200W-24V-KO	200W	110-277V	24V	CLASS 1	IP66 WET	10.2"	4.1"	1.8"
LLI-PS-UDIMM-288W-24V-CL2-KO	3x96W	110-277V	24V	CLASS 2	IP66 WET	11.8"	4.3"	1.8"
LLI-PS-UDIMM-300W-24V-KO	300W	110-277V	24V	CLASS 1	IP66 WET	10.9"	4.3"	1.8"

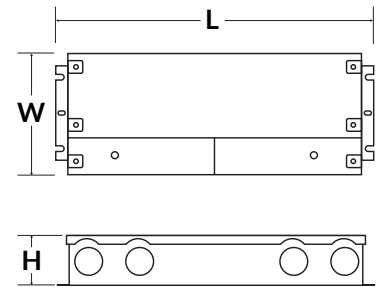

LUTRON HI-LUME PREMIER 0.1% DIMMABLE ELECTRONIC 

Soft-on, Fade-to-Black, continuous flicker-free dimming from 100% to 0.1.

PART NUMBER	CAPACITY	INPUT	OUTPUT	CLASS	LOCATION	L	W	H
L3D0-96W24V-U	96W	120-277V	24V	CLASS 2	IP20 DRY	10.5"	5.5"	2.0"

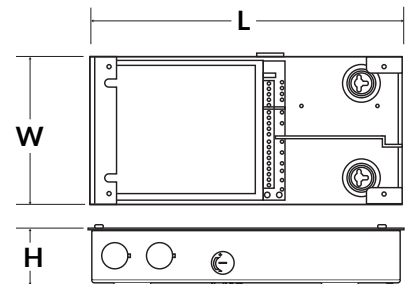

*Performance can be affected by driver loading and dimmer type.