

OUTDOOR WALL WASHER/GRAZER

SPECIFICATIONS

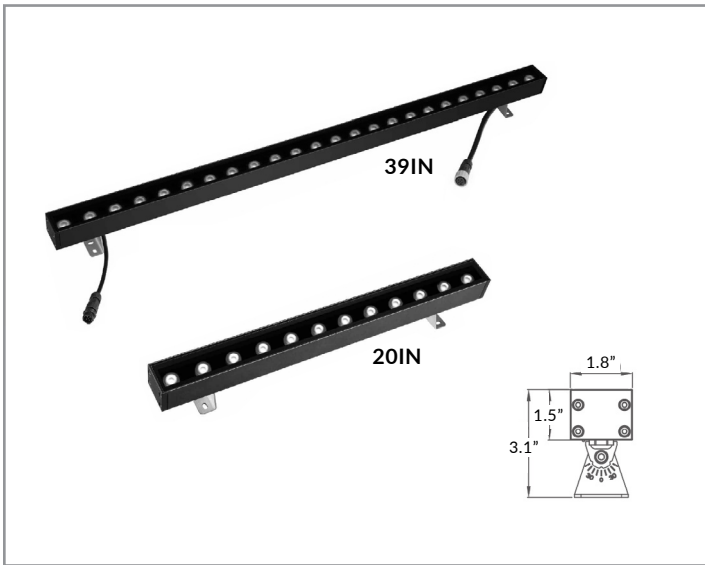

WATTAGE, CCT, & OUTPUT	20", 25W	39", 50W
		2700K - 2250 lumens 3000K - 2313 lumens 3500K - 2375 lumens 4200K - 2438 lumens 5200K - 2500 lumens
BEAM ANGLE	15°, 25°, 30°, 40°, 60°, 10x30°, 10x45°, 10x65°, 10x70°, 20x65°	
IP RATING	IP66 wet locations - wet locations. Not suitable for submersion, limited protection against harsh environments.	
INPUT VOLTAGE	24VDC	
CRI	80+	
OPERATING TEMP.	-4° to 104° F	
FINISH	Black powder coat	
LENS MATERIAL	Tempered glass	
WEIGHT	25W - 3.3 lb 50W - 6 lb	
DIMENSIONS	3.1" H x 1.8" W x 39" or 20" L	
MOUNTING	Adjustable locking bracket	
MAXIMUM RUN	Max run (3) 50W units, (6) 25W units or max 8A of combined lengths	
POWER CABLE & CONNECTORS	Each unit comes with 16" power cable on each end with IP65 rated connector -- see page 2 for power and jumper connector options	
POWER SUPPLY	Compatible with all 24VDC power supplies -- see page 3	



FEATURES & RECOMMENDED APPLICATIONS

Our outdoor wall washer/grazer product can be used for interior and exterior applications and is designed to highlight architectural features including surface textures, coves, and facade details. Different fixture lengths and beam angles allow for multiple surface illumination applications.

ORDERING GUIDE

Example part number: LLI-OWG-39IN50W-27K-40-66-24V

SERIES	LENGTH/ WATTAGE	CCT/ COLOR	BEAM ANGLE	IP RATING	INPUT
LLI-OWG				66	24V
	39IN50W	27K	15 - 15°	66 - IP66	24V - 24VDC
	20IN25W	30K	25 - 25°		
		35K	30 - 30°		
		42K	40 - 40°		
		52K	60 - 60°		
			1030 - 10x30°		
			1045 - 10x45°		
			1065 - 10x65°		
			1070 - 10x70°		
			2065 - 20x65°		

OUTDOOR WALL WASHER/GRAZER

POWER FEED & CONNECTOR OPTIONS (IP65)

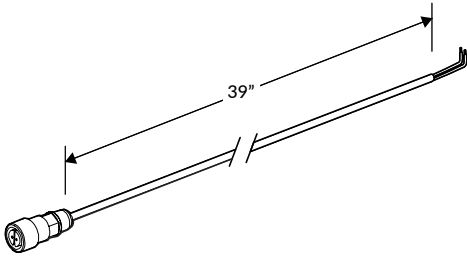

POWER CONNECTOR, 39IN

Power cable to connect OWG fixture to power supply (required for the start of each run)

LLI-OWG-65-PWR2-39IN

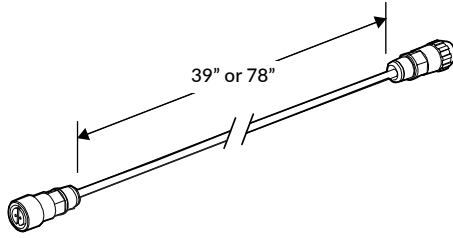

MALE TO FEMALE JUMPER CONNECTOR

Power connector for extending fixture-to-fixture distance (optional)

LLI-OWG-65-CON2 - 39IN
 78IN

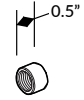

ENDCAP

Endcap for sealing power cable at the end of each run (required)

LLI-OWG-65-EC

LAYOUT DIAGRAM

Max run (3) 50W units, (6) 25W units or max 8A of combined lengths.

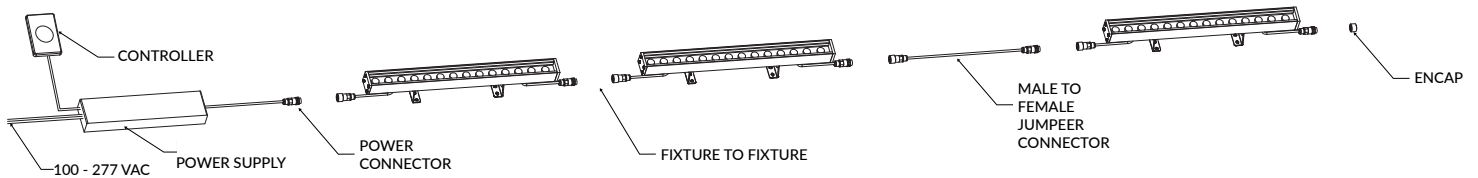

POWER SUPPLIES SOLD SEPARATELY

DIMMABLE ELECTRONIC 0-10V

Optimal performance dims to 0%.*



PART NUMBER	CAPACITY	INPUT	OUTPUT	CLASS	LOCATION	L	W	H
LLI-PS-DE010-030W-24V-KO	30W	120V or 277V	24V	CLASS 2	IP66 WET	6.5"	3.6"	1.6"
LLI-PS-DE010-060W-24V-KO	60W	120V or 277V	24V	CLASS 2	IP66 WET	7.4"	3.6"	1.6"
LLI-PS-DE010-096W-24V-KO	96W	120V or 277V	24V	CLASS 2	IP66 WET	8.7"	3.7"	1.7"
LLI-PS-DE010-200W-24V-KO	200W	120V or 277V	24V	CLASS 1	IP66 WET	10.2"	4.1"	1.8"
LLI-PS-DE010-300W-24V-KO	300W	120V or 277V	24V	CLASS 1	IP66 WET	10.9"	4.3"	1.8"

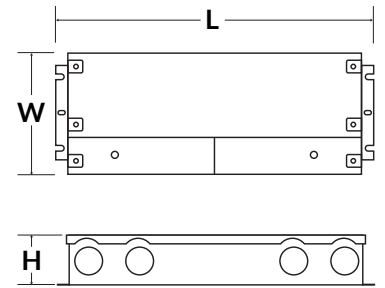

NON-DIMMABLE ELECTRONIC



PART NUMBER	CAPACITY	INPUT	OUTPUT	CLASS	LOCATION	L	W	H
LLI-PS-NDE-030W-24V-KO	30W	100-277V	24V	CLASS 2	IP66 WET	6.5"	3.5"	1.02"
LLI-PS-NDE-060W-24V-KO	60W	100-277V	24V	CLASS 2	IP66 WET	7.4"	3.5"	1.2"
LLI-PS-NDE-096W-24V-KO	96W	100-277V	24V	CLASS 2	IP66 WET	8.7"	3.7"	1.7"
LLI-PS-NDE-200W-24V-KO	200W	100-277V	24V	CLASS 1	IP66 WET	10.3"	4.1"	1.8"
LLI-PS-NDE-300W-24V-KO	300W	100-277V	24V	CLASS 1	IP66 WET	10.9"	4.3"	1.8"

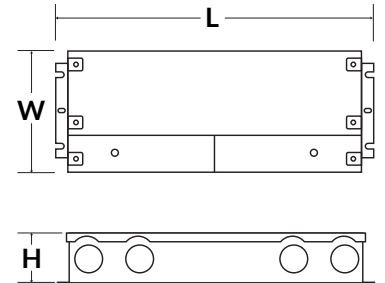

DIMMABLE ELECTRONIC FLICKER-FREE

Optimal performance dims to 2-5%.



PART NUMBER	CAPACITY	INPUT	OUTPUT	CLASS	LOCATION	L	W	H
LLI-PS-UDEFF-030W-24V-KO	30W	110-277V	24V	CLASS 2	IP66 WET	6.5"	3.6"	1.0"
LLI-PS-UDEFF-060W-24V-KO	60W	110-277V	24V	CLASS 2	IP66 WET	7.4"	3.6"	1.0"
LLI-PS-UDEFF-096W-24V-KO	96W	110-277V	24V	CLASS 2	IP66 WET	8.7"	3.7"	1.6"
LLI-PS-UDEFF-200W-24V-KO	200W	110-277V	24V	CLASS 1	IP66 WET	10.2"	4.1"	1.8"
LLI-PS-UDEFF-300W-24V-KO	300W	110-277V	24V	CLASS 1	IP66 WET	11.0"	4.3"	1.8"

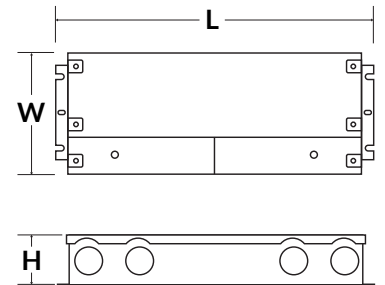

DIMMABLE MAGNETIC

Optimal performance dims to 5-10%.*



PART NUMBER	CAPACITY	INPUT	OUTPUT	CLASS	LOCATION	L	W	H
LLI-PS-DM-020W-24V-KO	20W	120V or 277V	24V	CLASS 2	NEMA 3R WET	7.38"	2.11"	1.60"
LLI-PS-DM-040W-24V-KO	40W	120V or 277V	24V	CLASS 2	NEMA 3R WET	7.38"	2.11"	1.60"
LLI-PS-DM-060W-24V-KO	60W	120V or 277V	24V	CLASS 2	NEMA 3R WET	8.13"	3.93"	1.59"
LLI-PS-DM-100W-24V-KO	100W	120V or 277V	24V	CLASS 2	NEMA 3R WET	8.13"	3.93"	1.59"
LLI-PS-DM-150W-24V-KO	150W	120V or 277V	24V	CLASS 1	NEMA 3R WET	8.79"	4.15"	3.41"
LLI-PS-DM-200W-24V-KO	200W	120V or 277V	24V	CLASS 1	NEMA 3R WET	8.79"	4.15"	3.41"
LLI-PS-DM-300W-24V-KO	300W	120V or 277V	24V	CLASS 1	NEMA 3R WET	8.79"	4.15"	3.41"
LLI-PS-DM-300W-24V-CL2-KO	6 x 50W	120V or 277V	24V	CLASS 2	NEMA 3R WET	10.29"	5.69"	3.43"
LLI-PS-DM-600W-24V-KO	2 x 300W	120V or 277V	24V	CLASS 1	NEMA 3R WET	10.29"	6.79"	4.68"

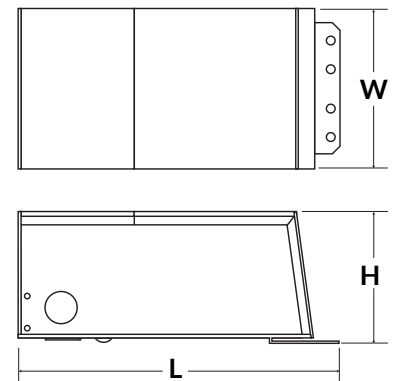

LUTRON HI-LUME PREMIER 0.1% DIMMABLE ELECTRONIC

Soft-on, Fade-to-Black, continuous flicker-free dimming from 100% to 0.1.



PART NUMBER	CAPACITY	INPUT	OUTPUT	CLASS	LOCATION	L	W	H
L3D0-96W24V-U	96W	120-277V	24V	CLASS 2	IP20 DRY	10.5"	5.5"	2.0"

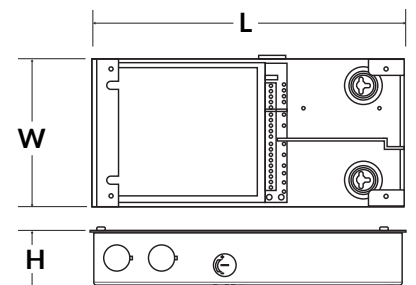

*Performance can be affected by driver loading and dimmer type.