

DIMMABLE MAGNETIC LED DRIVER



- Constant output voltage, 12V or 24V
- Dimming power supply
- Thermal primary and secondary self reset breakers
- Optimal performance dims to 5-10%.*



TECHNICAL INFORMATION

*NOTES: For optimal performance recommended loading is 80%. Performance can be affected by driver loading and dimmer type. For dimmer compatibility information, see page 4.

	INPUT	OUTPUT	WATTAGE	OPERATING TEMP.	WEIGHT	CLASS	RATING
LLI-PS-DM-020W-XXV-KO	120/277V	12V/24V	20W	Do not exceed 149° F	1.6 LB	Class 2	NEMA 3R
LLI-PS-DM-040W-XXV-KO	120/277V	12V/24V	40W	Do not exceed 149° F	2.3 LB	Class 2	NEMA 3R
LLI-PS-DM-060W-XXV-KO	120/277V	12V/24V	60W	Do not exceed 149° F	4.1 LB	Class 2	NEMA 3R
LLI-PS-DM-100W-XXV-KO	120/277V	12V/24V	100W	Do not exceed 149° F	4.6 LB	Class 2	NEMA 3R
LLI-PS-DM-150W-XXV-KO	120/277V	12V/24V	150W	Do not exceed 149° F	7.2 LB	Class 1	NEMA 3R
LLI-PS-DM-150W-12V-CL2-KO	120/277V	12V	3 x 50W	Do not exceed 149° F	8.5 LB	Class 2	NEMA 3R
LLI-PS-DM-200W-XXV-KO	120/277V	12V/24V	200W	Do not exceed 149° F	7.7 LB	Class 1	NEMA 3R
LLI-PS-DM-300W-XXV-KO	120/277V	12V/24V	300W	Do not exceed 149° F	8.4 LB	Class 1	NEMA 3R
LLI-PS-DM-300W-XXV-CL2-KO	120/277V	12V/24V	6 x 50W	Do not exceed 149° F	10 LB	Class 2	NEMA 3R
LLI-PS-DM-600W-XXV-KO	120/277V	12V/24V	2 x 300W	Do not exceed 149° F	18 LB	Class 1	NEMA 3R

PART NUMBER BUILDER / ORDERING GUIDE

Example part number: LLI-PS-DM-100W-24V-CL2-KO

SERIES	WATTAGE	OUTPUT	CLASS	INPUT	KNOCKOUT
LLI-PS-DM					KO
	020W 040W 060W 100W 150W 200W 300W 600W	12V 24V	blank - CL1 CL2 - Class 2	blank - 120V 277V	

DIMMABLE MAGNETIC LED DRIVER

DIMENSIONS

LLI-PS-DM-020W
LLI-PS-DM-040W

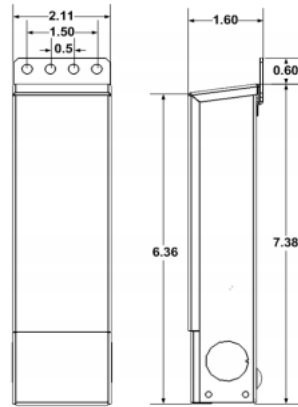

LLI-PS-DM-060W
LLI-PS-DM-100W

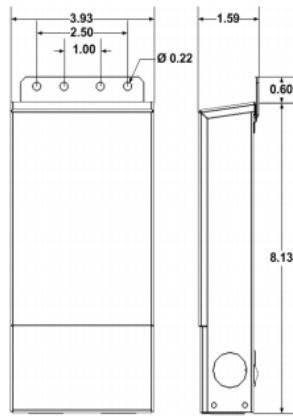

LLI-PS-DM-150W

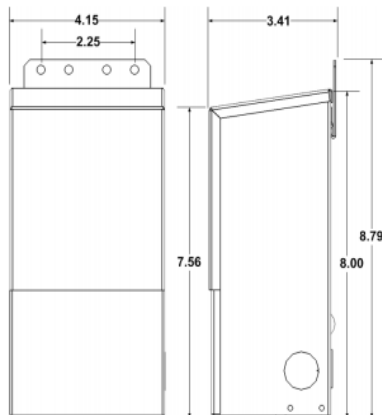

DIMMABLE MAGNETIC LED DRIVER

DIMENSIONS (CONTINUED)

LLI-PS-DM-150W-CL2

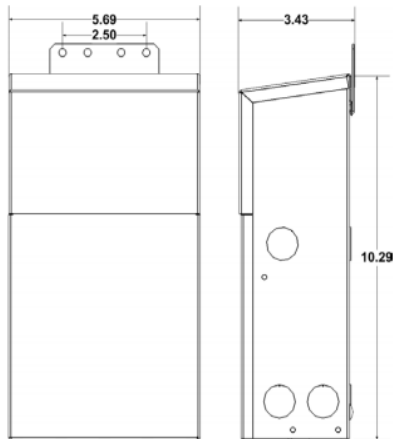

LLI-PS-DM-200W
LLI-PS-DM-300W

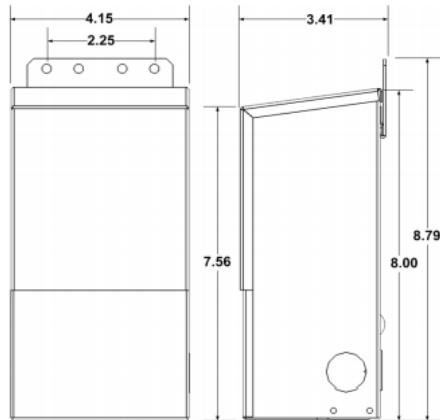

LLI-PS-DM-300W-CL2

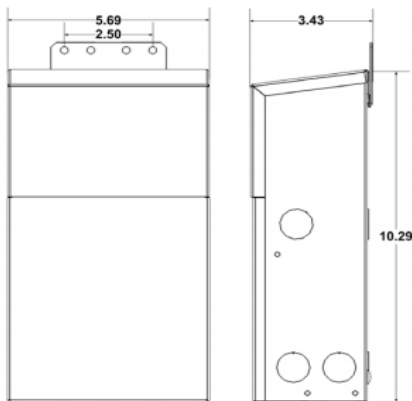

DIMMABLE MAGNETIC LED DRIVER

DIMENSIONS (CONTINUED)

LLI-PS-DM-600W

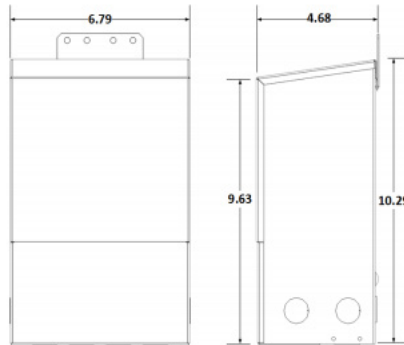

WIRING DIAGRAM

