

ELITE FLANGED EXTRUSION

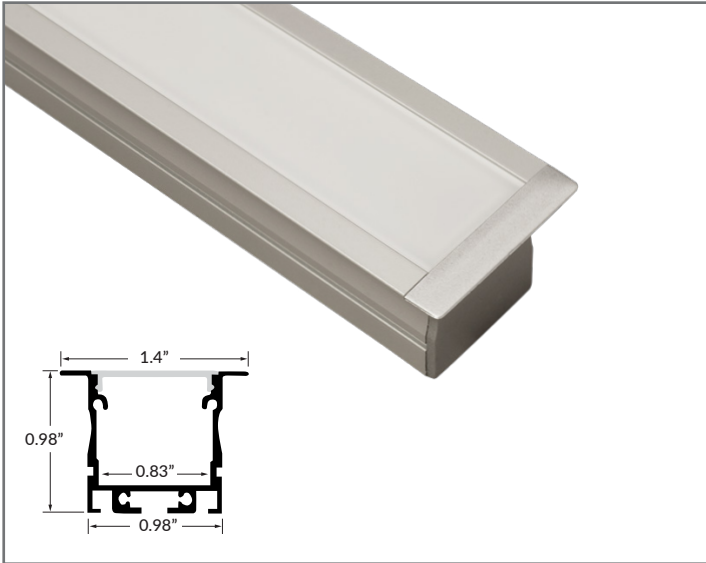

QUICK SPECIFICATIONS

| | |
|---------------------|-------------------------------------|
| BODY MATERIAL | Double anodized aluminum |
| LENS MATERIAL | Polycarbonate |
| MAX. LED TAPE WIDTH | Accommodates tapes up to 0.83" wide |
| DIMENSIONS | 1.4" W x 0.98" H |

FINISH

Standard finish is silver anodized.

Custom finishes available for any RAL #.
Additional price and MOQ may apply.

ACCESSORIES

Four (4) spring mounting clips included for each 48" or 94" section. Four (4) plastic endcaps included. Additional mounting clips and endcaps sold separately.

PART NUMBER BUILDER / ORDERING GUIDE

Example part number: LLI-XR-ELF-SA-F-48IN

| SERIES | FINISH | LENS | LENGTH |
|------------|--------------------|-----------|--|
| LLI-XR-ELF | SA | F | |
| | SA Silver Anodized | F Frosted | (enter custom length in inches, up to 94") |
| | | | 48IN 48" section |
| | | | 94IN 94" section |

ACCESSORIES

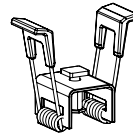

SPRING MOUNTING CLIP

Sold separately

LLI-XR-ELF-SMCL

1.0"L x 1.2" W x 1.7" H

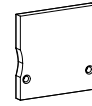

ENDCAP

4 endcaps included; extra endcaps sold separately

LLI-XR-ELF-EC

Screws included

FACTORY ASSEMBLED CORNERS (NO MITER CUTS REQUIRED. SCREWS AND JOINER BARS INCLUDED.)

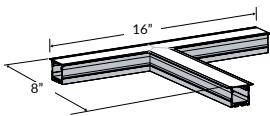

T CORNER

LLI-XS-ELF-SF-TEE-8IN

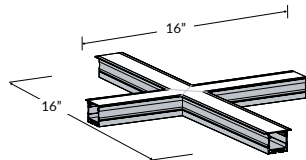

X CORNER

LLI-XS-ELF-SF-CROSS-8IN

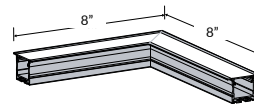

90° FLAT CORNER

LLI-XS-ELF-SF-90D-FLT-8IN

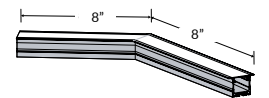

135° FLAT CORNER

LLI-XS-ELF-SF-135D-8IN

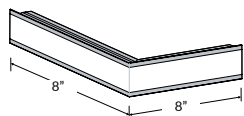

90° OUTSIDE CORNER

LLI-XS-ELF-SF-90D-OUT-8IN

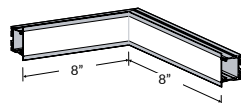

90° INSIDE CORNER

LLI-XS-ELF-SF-90D-INS-8IN