

ICON FLANGED EXTRUSION

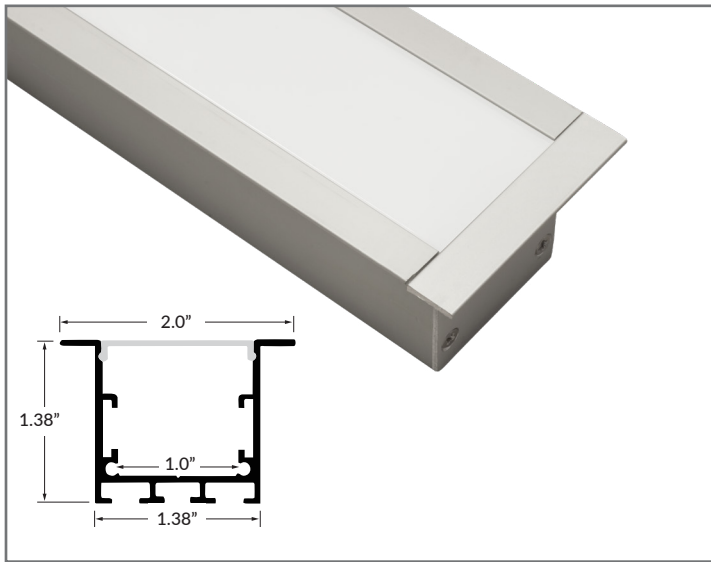

QUICK SPECIFICATIONS

BODY MATERIAL	Double anodized aluminum
LENS MATERIAL	Polycarbonate
MAX. LED TAPE WIDTH	Accommodates tapes up to 1" wide
DIMENSIONS	2.0" W x 1.38" H

FINISH

Standard finish is silver anodized.

MOUNTING

Two (2) spring mounting clips included for each 48" section. Four (4) spring mounting clips included for each 94" section. Additional clips sold separately.

ACCESSORIES

Four (4) plastic endcaps included. Additional endcaps sold separately.

PART NUMBER BUILDER / ORDERING GUIDE

Example part number: LLI-XR-ICF-SA-F-48IN

SERIES	FINISH	LENS	LENGTH
LLI-XR-ICF	SA		
	SA Silver Anodized	F Frosted C Clear	(enter custom length in inches, up to 94") 48IN 48" section 94IN 94" section

FACTORY ASSEMBLED CORNERS (NO MITER CUTS REQUIRED. SCREWS AND JOINER BARS INCLUDED.)

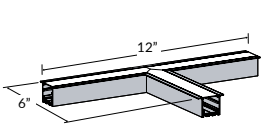

T CORNER

LLI-XR-ICF-SF-TEE-12IN

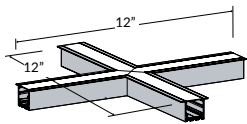

X CORNER

LLI-XR-ICF-SF-CROSS-12IN

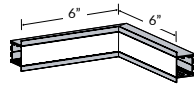

90° INSIDE CORNER

LLI-XR-ICF-SF-90D-INS-6IN

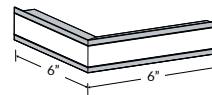

90° OUTSIDE CORNER

LLI-XR-ICF-SF-90D-OUT-6IN

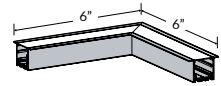

90° FLAT CORNER

LLI-XR-ICF-SF-90D-FLT-6IN

ACCESSORIES

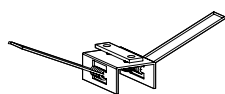

SPRING MOUNTING CLIP

LLI-XR-ICF-SMCL

0.6"L x 1.0" W x 0.25" D

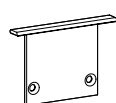

ENDCAPS

LLI-XR-ICF-EC

(Screws included)

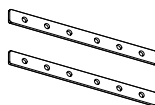

JOINER BARS

LLI-XR-ICF-JBAR-180

(Screws and hex wrench included)

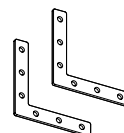

L JOINER BARS

LLI-XR-ICF-JBAR-90F

(Screws and hex wrench included)