

SEAMLESS 1.5 EXTRUSION

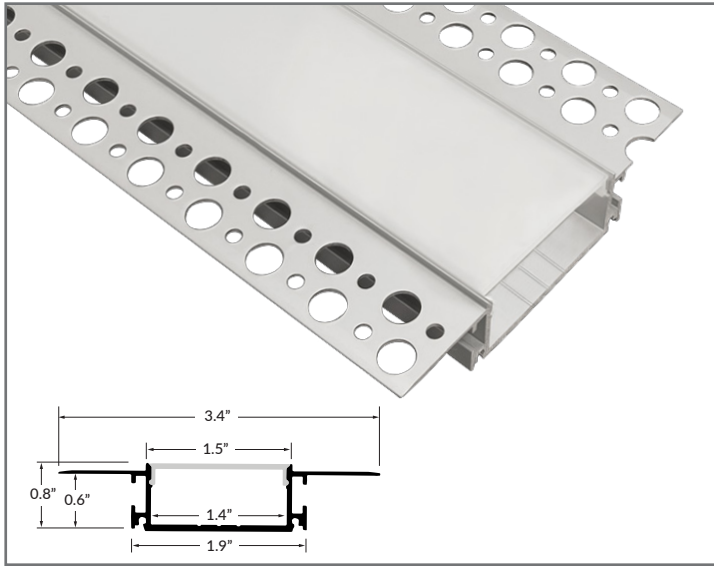

PART NUMBER BUILDER / ORDERING GUIDE

Example part number: LLI-XR-SM1.5-SA-F-48IN

| SERIES | FINISH | LENS | LENGTH |
|--------------|--------------------|-----------|--|
| LLI-XR-SM1.5 | SA | F | |
| | SA Silver Anodized | F Frosted | (enter custom length in inches, up to 94") 48IN 48" section 94IN 94" section |

QUICK SPECIFICATIONS

| | |
|---------------------|------------------------------------|
| BODY MATERIAL | Double anodized aluminum |
| LENS MATERIAL | Polycarbonate |
| MAX. LED TAPE WIDTH | Accommodates tapes up to 1.4" wide |
| DIMENSIONS | 3.4" W x 0.8" H |

FINISH

Standard finish is silver anodized.

MOUNTING

Fits a minimum 5/8" wall depth. Gypsum adhesive or mounting adhesive recommended (sold separately).

ACCESSORIES



ENDCAP

4 endcaps included; extra endcaps sold separately

LLI-XR-SM1.5-EC

FACTORY ASSEMBLED CORNERS (NO MITER CUTS REQUIRED. SCREWS AND JOINER BARS INCLUDED.)

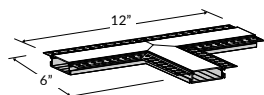

T CORNER

LLI-XR-SM1.5-SF-TEE-12IN

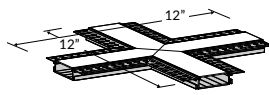

X CORNER

LLI-XR-SM1.5-SF-CROSS-12IN

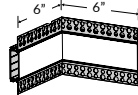

90° INSIDE CORNER

LLI-XR-SM1.5-SF-90D-INS-6IN

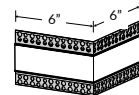

90° OUTSIDE CORNER

LLI-XR-SM1.5-SF-90D-OUT-6IN

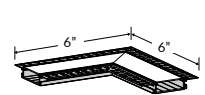

90° FLAT CORNER

LLI-XR-SM1.5-SF-90D-FLT-6IN

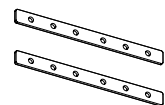

JOINER BARS

LLI-XR-SM1.5-JBAR-4IN

(Screws and hex wrench included)

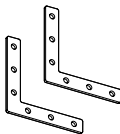

L JOINER BARS

LLI-XR-SM1.5-JBAR-90F

(Screws and hex wrench included)