

SEAMLESS 2.0 EXTRUSION

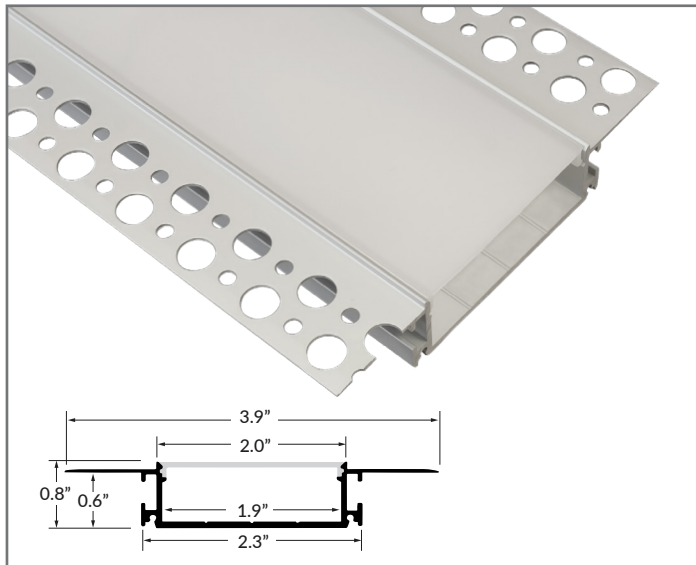

QUICK SPECIFICATIONS

BODY MATERIAL	Double anodized aluminum
LENS MATERIAL	Polycarbonate
MAX. LED TAPE WIDTH	Accommodates tapes up to 1.9" wide
DIMENSIONS	3.9" W x 0.8" H

FINISH

Standard finish is silver anodized.

MOUNTING

Fits a minimum 5/8" wall depth. Gypsum adhesive or mounting adhesive recommended (sold separately).

PART NUMBER BUILDER / ORDERING GUIDE

Example part number: LLI-XR-SM2-SA-F-48IN

SERIES	FINISH	LENS	LENGTH
LLI-XR-SM2	SA	F	
	SA Silver Anodized	F Frosted	(enter custom length in inches, up to 94") 48IN 48" section 94IN 94" section

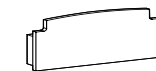

ENDCAP

4 endcaps included; extra endcaps sold separately

LLI-XR-SM2-EC

FACTORY ASSEMBLED CORNERS (NO MITER CUTS REQUIRED. SCREWS AND JOINER BARS INCLUDED.)

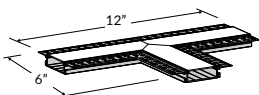

T CORNER

LLI-XR-SM2-SF-TEE-12IN

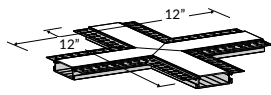

X CORNER

LLI-XR-SM2-SF-CROSS-12IN

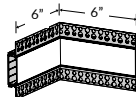

90° INSIDE CORNER

LLI-XR-SM2-SF-90D-INS-6IN

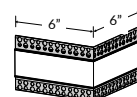

90° OUTSIDE CORNER

LLI-XR-SM2-SF-90D-OUT-6IN

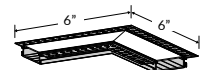

90° FLAT CORNER

LLI-XR-SM2-SF-90D-FLT-6IN

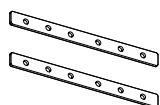

JOINER BARS

LLI-XR-SM2-JBAR-180

(Screws and hex wrench included)

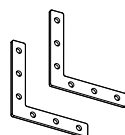

L JOINER BARS

LLI-XR-SM2-JBAR-90F

(Screws and hex wrench included)