

# ICON SIDE MOUNT EXTRUSION

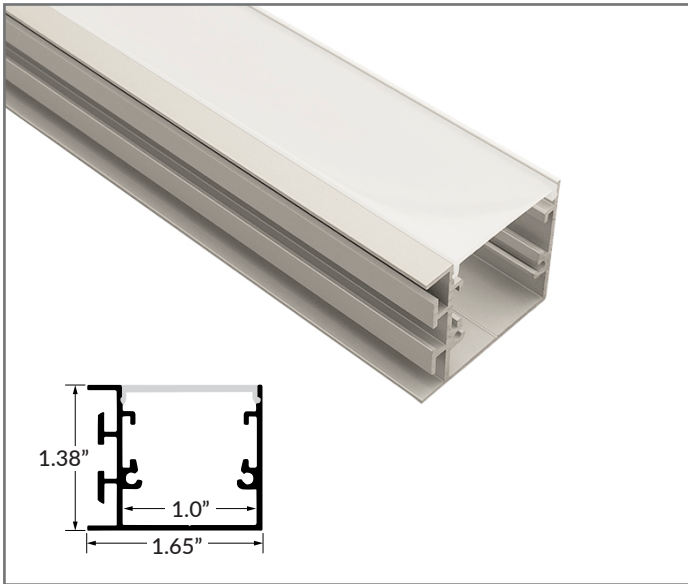

## QUICK SPECIFICATIONS

BODY MATERIAL	Double anodized aluminum
LENS MATERIAL	Polycarbonate
MAX. LED TAPE WIDTH	Accommodates tapes up to 1.0" wide
DIMENSIONS	1.65" W x 1.38" H

### FINISH

Standard finish is silver anodized or black anodized.

Custom finishes available for any RAL #. Additional price and MOQ may apply.

### ACCESSORIES

Four (4) mounting clips included for each 48" or 78" section. Four (4) endcaps included. Additional mounting clips and endcaps sold separately.

## PART NUMBER BUILDER / ORDERING GUIDE

Example part number: LLI-XS-ICS-SA-F-78IN

SERIES	FINISH	LENS	LENGTH
LLI-XS-ICS			
	SA Silver Anodized BL Black Anodized	F Frosted C Clear	(enter custom length in inches, up to 78") 48IN 48" section 78IN 78" section

## FACTORY ASSEMBLED CORNERS (NO MITER CUTS REQUIRED. SOLD SEPARATELY. SCREWS AND JOINER BARS INCLUDED.)

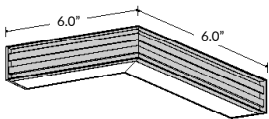

INSIDE CORNER

LLI-XS-ICS-SF-90D-INS-6IN

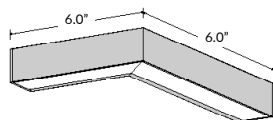

OUTSIDE CORNER

LLI-XS-ICS-SF-90D-OUT-6IN

## ACCESSORIES

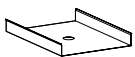

MOUNTING CLIP

LLI-XS-ICS-MCL

0.6"L x 1.0" W x 0.25" D

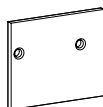

ENDCAPS

LLI-XS-ICS-EC

(Screws included)

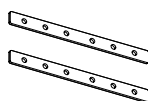

JOINER BARS

LLI-XS-ICS-JBAR-180

(Screws and hex wrench included)

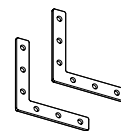

L JOINER BARS

LLI-XS-ICS-JBAR-90F

(Screws and hex wrench included)