

## SAFETY INFORMATION

**WARNING:** Do not connect directly to high voltage power (120V-277V). Use only with 24V DC hardwire or plug-in power supply. Factory warranty will be void if used otherwise.

- Read complete instruction.
- These products may represent a potential shock or fire hazard if improperly installed or attached in any way. Products should be installed in accordance with these instructions, local electrical codes and the National Electric Code (NEC).
- Do not energize LED tapelight when rolled up in its spool.
- Uncoated products are intended for indoor use in dry locations. Coated products are intended for outdoor use or in damp/wet locations. Refer to product spec sheet for location ratings.
- Do not use if there is any damage to the unit or to the wiring/insulation. Inspect periodically.
- Do not route cords or LED tapelight through walls, doors, windows or any similar part of a building structure.
- Do not secure LED tapelight or its power cord with staples, nails, or any other sharp objects that may cause damage.
- Do not install LED tape closer than 6" to combustible material.
- Ensure proper gauge wires are installed between Power Supplies, Controls & LED tapelight to avoid voltage drop.
- Ensure applicable wires are in compliance with local codes (In-wall rated, wet-location, high temperature, etc.).
- Recommended load for power supplies is 80%.

## ✓ required components to complete installation

- LED Tapelight
- Connectors (if applicable)
- Extrusion / Lens
- Mounting clips and or mounting adhesive
- 24V DC Power Supply

## Tapelight DO-NOT basics

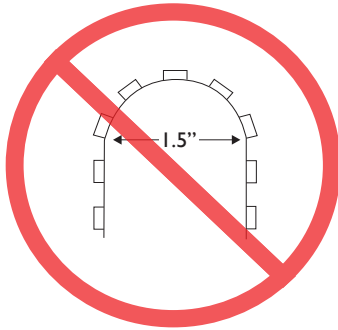

1.5" MINIMUM BEND RADIUS

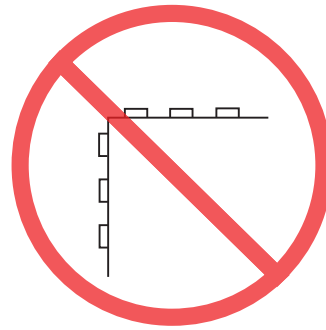

DO NOT FOLD OR CREASE  
LED TAPELIGHT

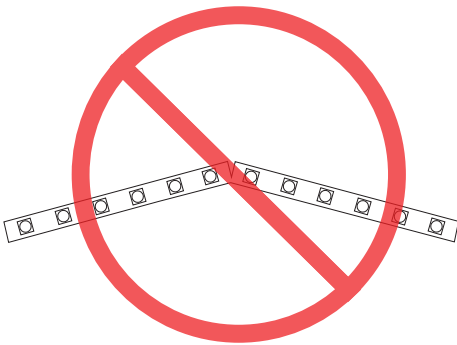

DO NOT BEND LED  
TAPELIGHT SIDE TO SIDE

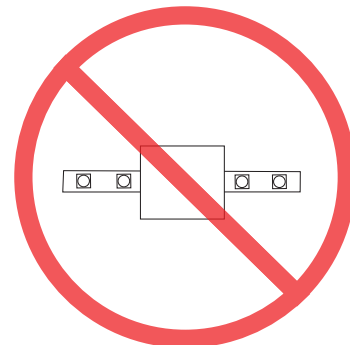

DO NOT COVER LED  
TAPELIGHT OR APPLY EXCESS  
PRESSURE TO LED TAPE

## Assemble Parts Together

**1**

**INSTALLATION NOTES:**

- Review all parts and quantities to confirm if all necessary parts are available.
- LED tapelight can only be cut at specific points. It is essential to dryfit your entire assembly to the cut point of your LED tapelight before routing/cutting out the mounting surface.

**CAUTION:** Use proper safety equipment when making any modification to parts.

1.1 If necessary, extrusion and lens can be cut on-site, using the proper equipment that cuts aluminum. Carefully cut to the desired length followed by cleaning off any material left after the cut.

1.2 Remove the lens from inside the extrusion, followed by cleaning the inside of the extrusion from any debris.

1.1 hacksaw or miter saw

extrusion and lens

1.2

**2**

**INSTALLATION NOTES:**

*Disregard steps 2-3, if using mounting clips.*

- Make countersunk holes to the center of the extrusion profile, for the mounting screws to sit flush.

2.1 Make three countersunk holes to the extrusion profile. Make the holes 1" from the ends of the extrusion. Followed by making another hole on-center. If the extrusion is over 60", add a fourth hole evenly spaced from each other.

2.1

1"

ON CENTER

1"

extrusion

countersunk hole

**3**

3.1 Align the extrusion to the surface, followed by securing to the surface with the screw.

3.1

screw

extrusion

INSTALLED

## Assemble Parts Together

**4**

4.1 If shortening LED tapelight, cut along the cut marks that are labeled in between the solder pads using utility shears.

4.2 Remove the red adhesive backing from the LED tapelight, then carefully apply the LED tapelight to the inside of the extrusion.

**INSTALLATION NOTES:**

- Make sure not to cut the side of the tapelight with lead wires.

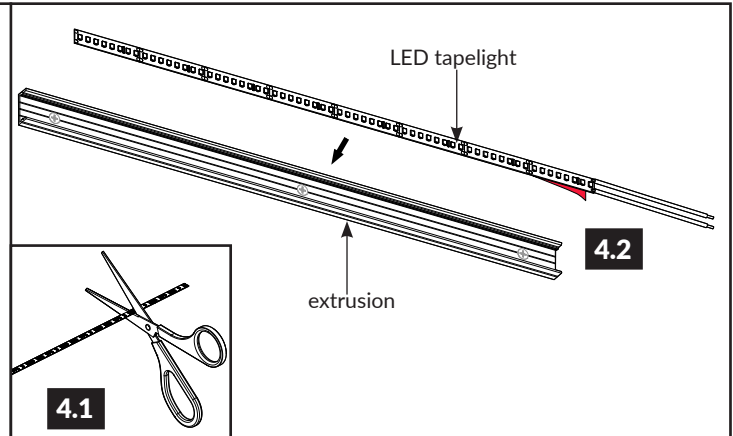

**5**

5.1 Carefully snap the lens into the top of the extrusion. Then, slide the endcaps into the extrusion to secure.

**INSTALLATION NOTES:**

- Slide endcap carefully through the power feed. Do not pull excessively on the power feed wires which can rip from the LED tapelight.

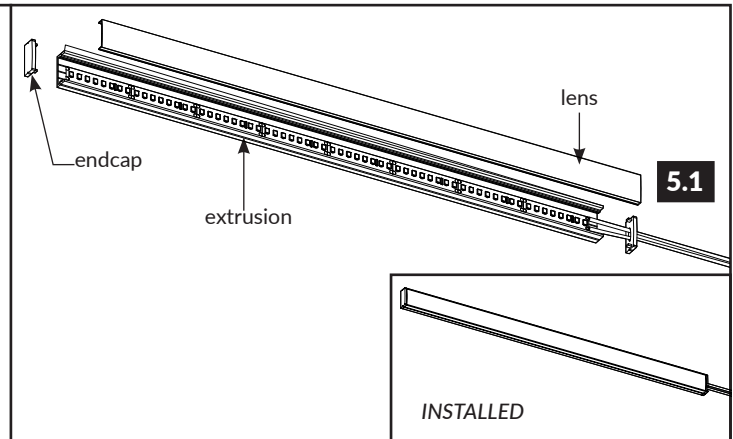

**6**

**INSTALLATION NOTES:**

- Mounting clips are needed 1" from each end of the extrusion followed by one on center. If the extrusion is over 60", install mountings clips every 30".

6.1 Align the mounting clips to the surface and secure using the appropriate hardware.

6.2 Snap extrusion into the mounting clips to secure in place.

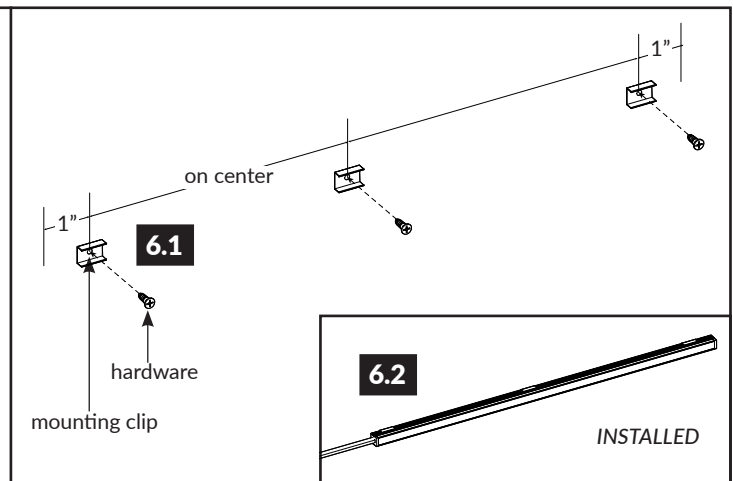

## Low Voltage Wire Gauge Chart

24V DC Voltage Drop and Wire Length (ft.) Distance Chart													
Power (W)	10W	20W	30W	40W	50W	60W	70W	80W	90W	100W	110W	120W	
Wire Gauge	#18	189'	94'	63'	47'	38'	31'	27'	24'	21'	19'	17'	16'
	#16	300'	149'	100'	76'	60'	50'	43'	37'	33'	30'	27'	25'
	#14	478'	238'	159'	120'	95'	79'	68'	60'	53'	48'	43'	40'
	#12	753'	274'	250'	189'	150'	125'	108'	94'	83'	75'	68'	63'
	#10	1205'	599'	400'	303'	240'	200'	172'	150'	133'	120'	109'	100'

### Typical Wiring Diagram - Static Color

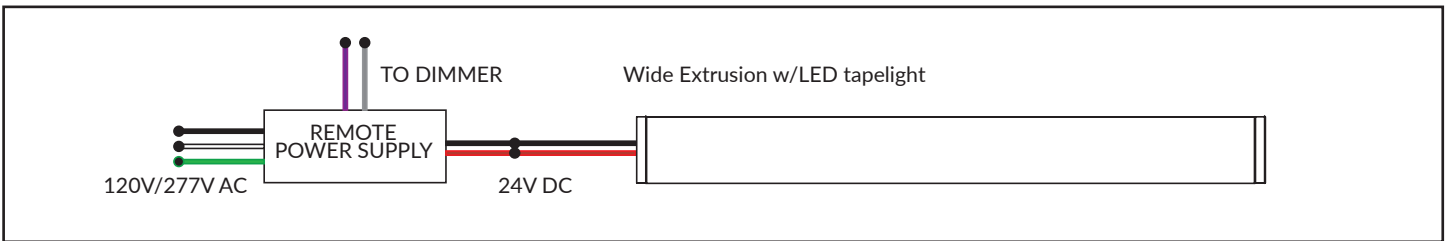

### Typical Wiring Diagram - Dynamic Color

